



Georgia State Supplements and Amendments to the International Energy Conservation Code (2015 Edition)



Georgia Department of Community Affairs
Community Development Division
60 Executive Park South, N.E.
Atlanta, Georgia 30329-2231
(404) 679-3118
www.dca.ga.gov

Revised January 1, 2020

**GEORGIA STATE MINIMUM STANDARD ENERGY CODE
(INTERNATIONAL ENERGY CONSERVATION CODE
WITH GEORGIA STATE SUPPLEMENTS AND AMENDMENTS)**

The **INTERNATIONAL ENERGY CONSERVATION CODE, 2015 Edition**, published by the International Code Council, when used in conjunction with these Georgia State Supplements, Amendments and any other Georgia State Amendments, shall constitute the official *Georgia State Minimum Standard Energy Code*.

GEORGIA STATE SUPPLEMENTS AND AMENDMENTS

SCOPE:

Each chapter of these Georgia State Supplements and Amendments corresponds with a chapter of the *International Energy Conservation Code (IECC)*.

Commercial Provisions

- Chapter 1: Scope and Administration
- Chapter 2: Definitions
- Chapter 3: General Requirements
- Chapter 4: Commercial Energy Efficiency
 - Compliance Pathways for Commercial and High-Rise Residential Construction:
 - Any of those delineated in this chapter; or
 - *COMcheck*¹
- Chapter 5: Existing Buildings
- Chapter 6: Referenced Standards

Residential Provisions

- Chapter 1: Scope and Administration
- Chapter 2: Definitions
- Chapter 3: General Requirements
- Chapter 4: Residential Energy Efficiency
 - Compliance Pathways for Low-Rise Residential Construction:
 - Any of those delineated in this chapter; or
 - *REScheck*¹
- Chapter 5: Existing Buildings
- Chapter 6: Referenced Standards
- Appendices RA, RB, RC and RD
 - Throughout the appendices, there is information that may be helpful in meeting and understanding the *Georgia State Minimum Standard Energy Code*. In cases of conflict, refer to the *IECC* for clarification.

1. *REScheck* and *COMcheck* are computer programs developed by Pacific Northwest National Laboratories for the U.S. Department of Energy (D.O.E.) to assist in demonstration of compliance with the *IECC*. They may be obtained free of charge from the D.O.E. online at www.energycodes.gov. When following the *REScheck* compliance pathway, select the 2015 *IECC* as the code version. When following the *COMcheck* compliance pathway, select either *IECC 2015* or *ASHRAE/IESNA Standard 90.1-2013*.

The ‘Mandatory’ requirements of the *IECC* apply to all compliance methods.

Where these Georgia State Supplements and Amendments conflict with either the *IECC* or *ANSI/ASHRAE/IES Standard 90.1*, these Georgia State Supplements and Amendments shall take precedence.

Air infiltration accounts for substantial heat loss, heat gain and moisture migration in a building. Proper sealing around all doors, windows and other envelope penetrations through the walls, ceiling and foundation is as important to code compliance as are proper insulation R-values and component U-factors.

It is not the intention of this code to abridge safety or health. Where the *IECC* and these Georgia State Supplements and Amendments conflict with other mandatory *State Minimum Standard Codes*, the *IECC* and these Georgia State Supplements and Amendments shall be enforced as written, provided that safety, health or environmental requirements of other mandatory *State Minimum Standard Codes* are not abridged.

APPENDICES:

Appendices are not enforceable unless they are specifically referenced in the body of the code or adopted by the Department of Community Affairs or the authority having jurisdiction.

This space intentionally left blank.

COMMERCIAL PROVISIONS

CHAPTER 1 [CE] SCOPE AND ADMINISTRATION

SECTION C101 SCOPE AND GENERAL REQUIREMENTS

*Delete Section C101.1 'Title' without substitution.
(Effective January 1, 2020)

*Add new Section C101.6 'Requirements for high-efficiency cooling towers' as follows:

C101.6 Requirements for high-efficiency cooling towers. Cooling towers installed in new construction shall be in compliance with ANSI/ASHRAE/IES 90.1 Standard.
(Effective January 1, 2020)

SECTION C104 INSPECTIONS

*Delete SECTION C104 'INSPECTIONS' without substitution.
(Effective January 1, 2020)

SECTION C107 FEES

*Delete SECTION C107 'FEES' without substitution.
(Effective January 1, 2020)

SECTION C108 STOP WORK ORDER

*Delete SECTION C108 'STOP WORK ORDER' without substitution.
(Effective January 1, 2020)

SECTION C109 BOARD OF APPEALS

*Delete SECTION C109 'BOARD OF APPEALS' without substitution.
(Effective January 1, 2020)

CHAPTER 2 [CE] DEFINITIONS

SECTION C202 GENERAL DEFINITIONS

*Revise the definition for ‘COEFFICIENT OF PERFORMANCE (COP) – COOLING’, as follows:

COEFFICIENT OF PERFORMANCE (COP) – COOLING. The ratio of the rate of heat removal to the rate of energy input, in consistent units, for a complete refrigerating system or some specific portion of that system under designated operating conditions.
(Effective January 1, 2020)

*Delete definition of ‘CONDITIONED SPACE’ and substitute the following:

SPACE. An enclosed space within a building. The classifications of spaces are as follows for the purpose of determining building envelope requirements:

(a) Conditioned space: a cooled space, heated space, or indirectly conditioned space is defined as follows:

(1) Cooled space: an enclosed space within a building that is cooled by a cooling system whose sensible output capacity exceeds 5 Btu/h·ft² of floor area.

(2) Heated space: an enclosed space within a building that is heated by a heating system whose output capacity relative to the floor area is greater than or equal to 5 Btu/h·ft².

(3) Indirectly conditioned space: an enclosed space within a building that is not a heated space or a cooled space, containing un-insulated ducts, or containing the heating equipment or which is heated or cooled indirectly by being connected to adjacent space(s), provided that air from heated or cooled spaces is transferred (naturally or mechanically) into the space. Unvented Attic Assemblies meeting the requirements of the IRC are an approved indirectly conditioned space.

(b) Semi-heated space: an enclosed space within a building that is heated by a heating system whose output capacity is greater than or equal to 3.4 Btu/h·ft² of floor area but is not a conditioned space.

(c) Unconditioned space: an enclosed space within a building that is not a conditioned space or a semi-heated space. Crawl spaces, attics, and parking garages with natural or mechanical ventilation are not considered enclosed spaces.

(Effective January 1, 2020)

*Add definition of ‘COOLING TOWER’ as follows:

COOLING TOWER. A building heat removal device used to transfer process waste heat to the atmosphere.

(Effective January 1, 2020)

* Delete definition of ‘ON-SITE RENEWABLE ENERGY’, and substitute the following:

ON-SITE RENEWABLE ENERGY. Energy systems that are located on the building site, are installed on the building’s side of the utility service provider’s meter, produce energy primarily intended for use in the building and not solely for export to utilities, and produce energy derived from any of the following sources: solar radiation, wind, waves, tides, biogas, biomass or the internal heat of the earth. Energy systems that derive energy from solar radiation shall be modeled in the orientation of the energy system.

The following description only pertains to energy systems that derive energy from solar radiation and are owned by a third-party. The Georgia Solar Power Free-Market Financing Act of 2015 (commonly referred to as “HB 57”) allows a customer to purchase solar electricity generated by a solar system owned by a third-party so long as certain criteria are met. Two key criteria are that the law only authorizes solar systems that generate electricity fueled by sunlight and that the solar system must be installed on property owned or occupied by the entity purchasing the system’s electricity. The definition of “property” extends to all adjacent contiguous tracts of land utilized by the entity purchasing the solar system’s electricity. “Building Site” in C202 is defined as a contiguous area of land that is under the ownership or control of one entity. While this definition of “building site” is similar to HB 57’s definition of “property,” the key difference is that HB 57 focuses on the entity purchasing the solar system’s electricity. When modeling a solar system that is owned by a third-party, it is best to refer to HB 57 to determine whether all criteria have been met.

(Effective January 1, 2020)

This space intentionally left blank.

**CHAPTER 4 [CE]
COMMERCIAL ENERGY EFFICIENCY**

**SECTION C402
BUILDING ENVELOPE REQUIREMENTS**

*Revise Table C402.1.3 ‘Opaque Thermal Envelope Insulation Component Minimum Requirements, R-Value Method^a’ *Climate Zone* 4 except Marine, for unheated slabs to read as follows:

TABLE C402.1.3 OPAQUE THERMAL ENVELOPE INSULATION COMPONENT MINIMUM REQUIREMENTS, R-VALUE METHOD^a		
Climate Zone	4 EXCEPT MARINE	
	All other	Group R
	Slab-on-grade floors	
Unheated slabs	NR	NR

(remainder of table left unchanged)

(Effective January 1, 2020)

**SECTION C403
BUILDING MECHANICAL SYSTEMS**

*Delete Section C403.2.3 ‘HVAC equipment performance requirements’ and substitute to read as follows:

C403.2.3 HVAC equipment performance requirements. Equipment shall meet the minimum efficiency requirements of Tables 6.8.1-1, 6.8.1-2, 6.8.1-3, 6.8.1-4, 6.8.1-5, 6.8.1-6, 6.8.1-7, 6.8.1-9, 6.8.1-10, 6.8.1-11, 6.8.1-12, and 6.8.1-13 of ASHRAE Standard 90.1 when tested and rated in accordance with the applicable test procedure. Plate-type liquid-to-liquid heat exchangers shall meet the minimum requirements of Table 6.8.1-8 of ASHRAE Standard 90.1. The efficiency shall be verified through certification under an *approved* certification program or, where a certification program does not exist, the equipment efficiency ratings shall be supported by data furnished by the manufacturer. Where multiple rating conditions or performance requirements are provided, the equipment shall satisfy all stated requirements. Where components, such as indoor or outdoor coils, from different manufacturers are used, calculations and supporting data shall be furnished by the designer that demonstrates that the combined efficiency of the specified components meets the requirements herein.

The above referenced tables of ASHRAE 90.1, HVAC equipment performance tables are available to download for free from DCA’s webpage located at: <https://dca.ga.gov/node/3522/documents/2085> (Effective January 1, 2020)

*Delete Section C403.2.8 'Kitchen Exhaust Systems' without substitution.
(Effective January 1, 2020)

*Delete Table C403.2.8 'MAXIMUM NET EXHAUST FLOW RATE, CFM PER LINEAR FOOT OF HOOD LENGTH' without substitution.
(Effective January 1, 2020)

*Delete Section C403.2.9 'Duct and plenum insulation and sealing' and substitute to read as follows:

C403.2.9 Duct and plenum insulation and sealing. Supply and return air ducts and plenums shall be insulated with a minimum of R-6 insulation where located in unconditioned spaces and where located outside the building with a minimum of R-8 insulation in *Climate Zones 2 through 4*. Where located within a building envelope assembly, the duct or plenum shall be separated from the building exterior or unconditioned or exempt spaces by a minimum of R-8 insulation in *Climate Zones 2 through 4*.

Exceptions:

1. Where located within equipment.
2. Where the design temperature difference between the interior and exterior of the duct or plenum is not greater than 15°F (8°C).

Ducts, air handlers and filter boxes shall be sealed. Joints and seams shall comply with section C403.2.9.2 of these Georgia State Supplements and Amendments.

Exceptions:

1. Air-impermeable spray foam product shall be permitted to be applied without additional joint seals.
 2. For ducts having a static pressure classification of less than 2 inches of water column (500 Pa), additional closure systems shall not be required for continuously welded joints and seams, and locking-type joints and seams of other than the snap-lock and button-lock types.
 3. Where a duct connection is made that is partially inaccessible, three screws or rivets shall be equally spaced on the exposed portion of the joint so as to prevent a hinge effect.
 4. Sealing that would void product listings is not required.
- (Effective January 1, 2020)

*Add new Section C403.2.9.2 'Joints, seams and Connections' as follows:

C403.2.9.2 Joints, Seams and Connections. All longitudinal and transverse joints, seams and connections in metallic and nonmetallic ducts shall be constructed as specified in *SMACNA HVAC Duct Construction Standards- Metal and Flexible* and *NAIMA Fibrous Glass Duct Construction Standards*. All joints, longitudinal and transverse seams, and connections in ductwork shall be securely fastened and sealed with welds, gaskets, mastics (adhesives), mastic-plus-embedded-fabric systems or tapes. Without exception all closure systems shall have mastic applied that is at least 0.08 inches (2 mm) thick.

Closure systems used to seal flexible air ducts and flexible air connections shall comply with UL 181B and shall be marked “181B-FX” for pressure-sensitive tape or “181B-M” for mastic. Duct connections to flanges of air distribution systems equipment shall be sealed and mechanically fastened. Mechanical fasteners for use with flexible non-metallic air ducts shall comply with UL 181B and shall be marked 181B-C. Crimp joints for round metallic ducts shall have a contact lap of not less than 1 inch (25.4 mm) and shall be mechanically fastened by means of not less than three sheet-metal screws or rivets equally spaced around the joint.

Closure systems used to seal metal ductwork shall be installed in accordance with manufacturer’s instructions. Round metallic ducts shall be mechanically fastened by means of at least three sheet metal screws or rivets spaced equally around the joint. Unlisted duct tape shall not be permitted as a sealant on any duct.

Exceptions:

1. Spray polyurethane foam shall be permitted to be applied without additional joint seals.
2. Where a duct connection is made that is partially inaccessible, three screws or rivets shall be equally spaced on the exposed portion of the joint so as to prevent a hinge effect.
3. Continuously welded and locking-type longitudinal joints and seams in ducts operating at static pressure less than 2 inches (51 mm) of water column (500 Pa) pressure classification shall not require additional closure systems.

(Effective January 1, 2020)

*Revise Section C403.3 ‘Economizers (Prescriptive)’ as follows:

C403.3 Economizers (Prescriptive).

Revise Section C403.3, Economizers (Prescriptive), to delete the last sentence of exception 2 and add exception number 10, Computer Room Applications, at the end.

10. Computer Room Applications

(Effective January 1, 2020)

*Delete Section C403.4.2.6 ‘Pump isolation’ to add a new sentence at the end to read as follows:

C403.4.2.6 Pump isolation. Chilled water plants including more than one chiller shall have the capability to reduce flow automatically through the chiller plant when a chiller is shut down. Chillers piped in series for the purpose of increased temperature differential shall be considered as one chiller.

Boiler plants including more than one boiler shall have the capability to reduce flow automatically through the boiler plant when a boiler is shut down. Flow isolation shall allow time for adequate thermal dissipation of residual heat to prevent relief before isolating boiler(s).

(Effective January 1, 2020)

**SECTION C407
TOTAL BUILDING PERFORMANCE**

*Delete Section C407.3 ‘Performance-based compliance’ and substitute to read as follows:

C407.3 Performance-based compliance. Compliance based on total building performance requires that a proposed building (*proposed design*) be shown to have an annual energy cost that is less than or equal to the annual energy cost of the *standard reference design*. Energy prices shall be taken from a source *approved* by the *code official*, such as the Department of Energy, Energy Information Administration's *State Energy Price and Expenditure Report*. *Code officials* shall be permitted to require time-of-use pricing in energy cost calculations.

The reduction in annual energy cost of the *proposed design* associated with *on-site renewable energy* shall be not more than 5% of the total annual energy cost. The amount of renewable energy purchased from off-site sources shall be the same in the *standard reference design* and the *proposed design*.

Exception: Jurisdictions that require site energy (1 kWh = 3413 Btu) rather than energy cost as the metric of comparison.

(Effective January 1, 2020)

*Revise Section C407.4.2 ‘Additional documentation’ to add a new item 6 to read as follows:

C407.4.2 Additional documentation.

6. Documentation of the reduction in annual energy use associated with on-site renewable energy.

**SECTION C408
SYSTEM COMMISSIONING**

*Revise Section C408 ‘System Commissioning’ as follows:

Strike the words “commission” and “commissioning” wherever they appear and replace with “functional performance testing” throughout the entire Section C408 SYSTEM COMMISSIONING as required.

(Effective January 1, 2020)

*Delete Section C408.2.4.1 ‘Acceptance of report’ without substitution.

(Effective January 1, 2020)

**CHAPTER 6 [CE]
REFERENCED STANDARDS**

*Revise Chapter 6 ‘Referenced Standards’ to add the following new Standards to read as follows:

UL UL LLC
 333 Pfingsten Road
 Northbrook, IL 60062-2096

Standard reference number	Title	Referenced in code section number
181—2013	Factory-made Air Ducts and Air Connectors—with Revisions through May 2003	C403.2.9.2
181A—2013	Closure Systems for Use with Rigid Air Ducts and Air Connectors—with Revisions through December 1998	C403.2.9.2
181B—2013	Closure Systems for Use with Flexible Air Ducts and Air Connectors—with Revisions through August 2003.....	C403.2.9.2

(Standards not listed to remain unchanged)

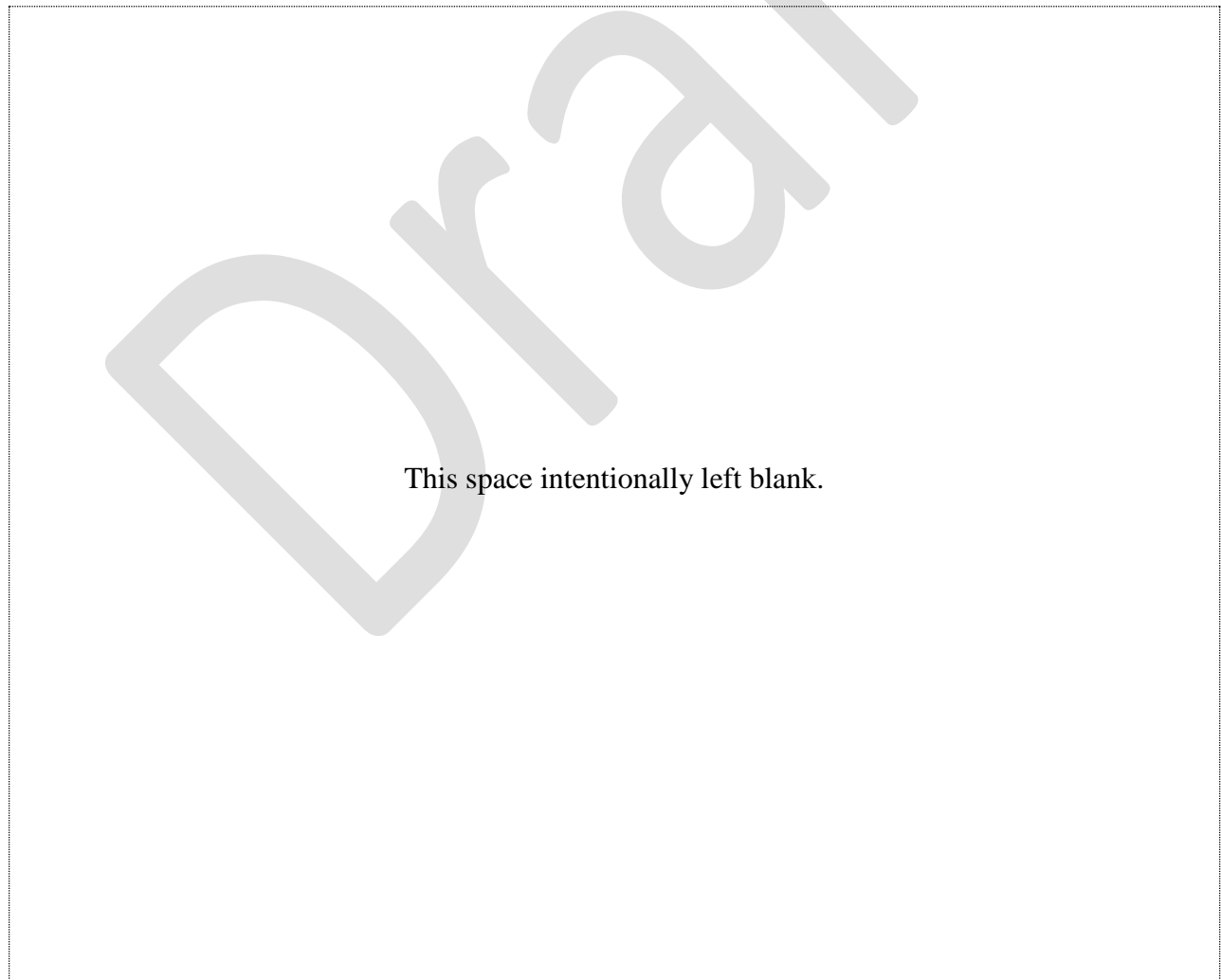

RESIDENTIAL PROVISIONS

**CHAPTER 1 [RE]
SCOPE AND ADMINISTRATION**

**SECTION R101
SCOPE AND GENERAL REQUIREMENTS**

*Delete Section R101.1 'Title' without substitution.
(Effective January 1, 2020)

**SECTION R103
CONSTRUCTION DOCUMENTS**

*Delete SECTION R103 'CONSTRUCTION DOCUMENTS' without substitution.
(Effective January 1, 2020)

**SECTION R104
INSPECTIONS**

*Delete SECTION R104 'INSPECTIONS' without substitution.
(Effective January 1, 2020)

**SECTION R107
FEES**

*Delete SECTION R107 'FEES' without substitution.
(Effective January 1, 2020)

**SECTION R108
STOP WORK ORDER**

*Delete SECTION R108 'STOP WORK ORDER' without substitution.
(Effective January 1, 2020)

**SECTION R109
BOARD OF APPEALS**

*Delete SECTION R109 'BOARD OF APPEALS' without substitution.
(Effective January 1, 2020)

CHAPTER 2 [RE] DEFINITIONS

*Add definition of ‘ATTIC KNEEWALL’ as follows:

ATTIC KNEEWALL. Any vertical or near-vertical wall in the building envelope that has conditioned space on one side and unconditioned attic space on the other side. If the envelope features the insulation installed along the sloped ceiling, the vertical wall is considered an interior wall and thus does not require insulation.
(Effective January 1, 2020)

*Add new definition of ‘CERTIFIED DUCT AND ENVELOPE TIGHTNESS (DET) VERIFIER’ as follows:

CERTIFIED DUCT AND ENVELOPE TIGHTNESS (DET) VERIFIER. A certified DET verifier shall be a certified Home Energy Rating Systems (HERS) rater, or be a Building Performance Institute (BPI) Analyst, or be an Infiltration Duct Leakage (IDL) Certified, or successfully complete a certified DET verifier course that is approved by the Georgia Department of Community Affairs.
(Effective January 1, 2020)

*Delete definition of ‘CONDITIONED SPACE’ and substitute as follows:

SPACE. An enclosed space within a building. The classifications of spaces are as follows for the purpose of determining building envelope requirements:

(a) Conditioned space: a cooled space, heated space, or indirectly conditioned space is defined as follows:

(1) Cooled space: an enclosed space within a building that is cooled by a cooling system whose sensible output capacity exceeds 5 Btu/h·ft² of floor area.

(2) Heated space: an enclosed space within a building that is heated by a heating system whose output capacity relative to the floor area is greater than or equal to 5 Btu/h·ft².

(3) Indirectly conditioned space: an enclosed space within a building that is not a heated space or a cooled space, containing un-insulated ducts, or containing the heating equipment or which is heated or cooled indirectly by being connected to adjacent space(s), provided that air from heated or cooled spaces is transferred (naturally or mechanically) into the space. Unvented Attic Assemblies meeting the requirements of the IRC are an approved indirectly conditioned space.

(b) Semi-heated space: an enclosed space within a building that is heated by a heating system whose output capacity is greater than or equal to 3.4 Btu/h·ft² of floor area but is not a conditioned space.

(c) Unconditioned space: an enclosed space within a building that is not a conditioned space or a semi-heated space. Crawl spaces, attics, and parking garages with natural or mechanical ventilation are not considered enclosed spaces.

(Effective January 1, 2020)

* Add definition of ‘ON-SITE RENEWABLE ENERGY’ as follows:

ON-SITE RENEWABLE ENERGY. Energy systems that are located on the building site, are installed on the building’s side of the utility service provider’s meter, produce energy primarily intended for use in the building and not solely for export to utilities, and produce energy derived from any of the following sources: solar radiation, wind, waves, tides, biogas, biomass or the internal heat of the earth. Energy systems that derive energy from solar radiation shall be modeled in the orientation of the energy system.

The following description only pertains to energy systems that derive energy from solar radiation and are owned by a third-party. The Georgia Solar Power Free-Market Financing Act of 2015 (commonly referred to as “HB 57”) allows a customer to purchase solar electricity generated by a solar system owned by a third-party so long as certain criteria are met. Two key criteria are that the law only authorizes solar systems that generate electricity fueled by sunlight and that the solar system must be installed on property owned or occupied by the entity purchasing the system’s electricity. The definition of “property” extends to all adjacent contiguous tracts of land utilized by the entity purchasing the solar system’s electricity. “Building Site” in R202 is defined as a contiguous area of land that is under the ownership or control of one entity. While this definition of “building site” is similar to HB 57’s definition of “property,” the key difference is that HB 57 focuses on the entity purchasing the solar system’s electricity. When modeling a solar system that is owned by a third-party, it is best to refer to HB 57 to determine whether all criteria have been met.

(Effective January 1, 2020)

**CHAPTER 4 [RE]
RESIDENTIAL ENERGY EFFICIENCY**

**SECTION R401
GENERAL**

*Revise Section R401.2 ‘Compliance’ as follows:

R401.2 Compliance. Projects shall comply with all provisions of Chapter 4 labeled “Mandatory” and one of the following:

1. Sections R401 through R404.
2. Section R405.
3. Section R406.
4. The most recent version of REScheck, keyed to the 2015 IECC.

*Revise Section R401.3 ‘Certificate (Mandatory)’ by revising first sentence and adding at end as follows:

R401.3 Certificate (Mandatory). A permanent certificate shall be completed by the builder or registered design professional and posted on or near the electrical distribution panel or air handler. Where located on ... (Middle of section left unchanged) ... water heating equipment. Refer to Appendix RD for the Mandatory Compliance Certificate that shall be used. (Remainder of section left unchanged) (Effective January 1, 2020)

The above referenced form, Mandatory Compliance Certificate is available to download for free from DCA’s webpage located at: <https://dca.ga.gov/node/3522/documents/2090>

**SECTION R402
BUILDING THERMAL ENVELOPE**

*Revise Table R402.1.2 ‘Insulation and Fenestration Requirements by Component^a’ as follows:

TABLE R402.1.2 INSULATION AND FENESTRATION REQUIREMENTS BY COMPONENT^a											
Climate Zone	Fenestration U-Factor ^b	Skylight ^b U-Factor	Glazed Fenestration SHGC ^{b,e}	Ceiling R-Value	Wood Frame Wall R-Value	Attic Kneewall R-Value ⁱ	Mass Wall R-Value	Floor R-Value	Basement ^c Wall R-Value	Slab ^d R-Value & Depth	Crawl Space ^c Wall R-Value
2	0.35	0.65	0.27	38	13	18	4/6	13	0	0	0
3	0.35	0.55	0.27	38	13	18	8/13	19	5/13 ^f	0	5/13
4 except marine	0.35	0.55	0.27	38	13	18	8/13	19	10/13	0	10/13

(Remainder of footnotes left unchanged) (Effective January 1, 2020)

*Revise Table R402.1.4 ‘Equivalent *U*-Factors^a’ as follows:

TABLE R402.1.4 EQUIVALENT <i>U</i> -FACTORS ^a								
Climate Zone	Fenestration <i>U</i> -Factor	Skylight <i>U</i> -Factor	Ceiling <i>U</i> -Factor	Frame Wall <i>U</i> -Factor	Mass Wall <i>U</i> -Factor ^b	Floor <i>U</i> -Factor	Basement Wall <i>U</i> -Factor	Crawl Space Wall <i>U</i> -Factor
2	0.35	0.65	0.030	0.084	0.165	0.064	0.360	0.477
3	0.35	0.55	0.030	0.084	0.098	0.047	0.091 ^c	0.136
4 except marine	0.35	0.55	0.030	0.084	0.098	0.047	0.059	0.065

Table footnote left unchanged (Effective January 1, 2020)

*Add a new Section R402.1.6 ‘Compliance Alternative Constraints (Mandatory)’ as follows:

R402.1.6 Compliance Alternative Constraints. (Mandatory) Where Compliance Alternative Pathways are used, the minimum *R*-values, maximum *U*-factors, and maximum SHGCs for thermal envelope components in projects complying under this code (including the use of REScheck) shall be according to Table 402.1.6. Compliance Alternative Pathways include Total UA Alternative, Simulated Performance Alternative, and Energy Rating Index Alternative.

*Add a new Table 402.1.6, ‘Minimum Insulation *R*-Values for Envelope Components When Trade-offs Are Used’ to read as follows:

Table R402.1.6 MINIMUM INSULATION <i>R</i> -VALUES FOR ENVELOPE COMPONENTS WHEN TRADE-OFFS ARE USED										
Climate Zone	Wood ^a Framed Walls	Mass ^{a, b} Wall	Attic ^{a, c} Kneewall	Basement ^a Wall	Crawl ^a Wall	Floor Over Unheated Spaces	Ceilings with Attic Space	Vaulted ^{c, d} Unvented Attic Roofline Air-impermeable	Vaulted ^{c, d} Unvented Attic Roofline Air-permeable	Cathedralized ^{c, d} Vented Ceiling Roofline Air-permeable
2	13	4	18	0	0	13	30	20	20+5*	20
3	13	5	18	5	5	13	30	20	20+5*	20
4	13	5	18	5	5	13	30	20	20+15*	20
Window <i>U</i> -Factor 0.5 max with SHGC 0.30 max								* Air -impermeable as per IRC 806.5		
<p>a: Weather-stripped hinged vertical doors (minimum <i>R</i>-5 insulation or maximum <i>U</i>-0.20), weather-stripped hatches/scuttle hole covers (minimum <i>R</i>-19 insulation or maximum <i>U</i>-0.05), or weather-stripped and disappearing/ pull-down stairs (minimum <i>R</i>-5 insulation or maximum <i>U</i>-0.20) shall be deemed to meet the minimum insulation <i>R</i>-values of the corresponding envelope element.</p> <p>b: Any mass wall (masonry, CMU, etc.)</p> <p>c: Attic kneewall for the purpose of this code is defined as any vertical or near vertical wall in the building envelope that has conditioned space on one side and attic space on the other side.</p> <p>Exception: When the building roofline is insulated, the former kneewall is classified as an interior wall.</p> <p>d: Examples of air-impermeable insulation include spray foam and rigid foam board. Examples of air-permeable insulation include fiberglass batts and cellulose. See ‘Roofline Installed Insulation Options’ in Appendix RA, of these Georgia State Supplements and Amendments for details.</p>										

(Effective January 1, 2020)

*Revise Section R402.2.1 ‘Ceilings with attic spaces’ as follows:

R402.2.1 Ceilings with attic spaces. Where Section R402.1.2 would require R-38 insulation in the ceiling, installing R-30 over 100 percent of the ceiling area requiring insulation shall be deemed to satisfy the requirement for R-38 wherever the full height of uncompressed R-30 insulation extends completely over the wall top plate at the eaves.

This reduction shall not apply to the U-factor alternative approach in Section R402.1.4 and the total UA alternative in Section R402.1.5.

For HVAC attic platforms used for locating and servicing equipment, R-19 (maximum *U*-Factor 0.047) shall be deemed to meet the requirements of R-38 (maximum *U*-Factor 0.027) in the ceiling. R-19 is deemed acceptable for up to 32 square feet of attic decking per HVAC system. R-19 shall be deemed acceptable for a maximum 32 inch wide passage to the HVAC system as referenced under M1305.1.3 of the International Residential Code.
(Effective January 1, 2020)

*Delete Section R402.2.3 ‘Eave baffle’ and substitute to read as follows:

R402.2.3 Eave baffle. For air permeable insulation in vented attics, baffles shall be installed adjacent to soffit and eave vents. A minimum of a 1-inch of space shall be provided between the insulation and the roof sheathing and at the location of the vent. The baffle shall extend over the top of the insulation inward until it is at least 4 inches vertically above the top of the insulation. Any solid material such as cardboard or thin insulating sheathing shall be permissible as the baffle. (See Appendix RA for further clarification.)
(Effective January 1, 2020)

*Delete Section R402.2.4 ‘Access hatches and doors’ and substitute the following:

R402.2.4 Access hatches and doors. Access doors from conditioned spaces to unconditioned spaces (e.g. attics, unconditioned basements and crawl spaces) shall be weather-stripped and insulated in accordance with the following insulation values:

1. Hinged vertical doors shall have a maximum *U*-Factor of U-0.20 (R-5 minimum);
2. Hatches/scuttle hole covers shall have a maximum *U*-Factor of U-0.05 (R-19 minimum);
and
3. Pull down stairs shall have a maximum *U*-Factor of U-0.20 with a minimum of 75 percent of the panel area having (R-5 minimum) insulation.

Access shall be provided to all equipment which prevents damaging or compressing the insulation. A wood framed or equivalent baffle or retainer is required to be provided when loose fill insulation is installed, the purpose of which is to prevent the loose fill insulation from spilling into the living space when the attic access is opened, and to provide a permanent means of maintaining the installed *R*-value of the loose fill insulation.
(Effective January 1, 2020)

*Delete Section R402.2.11 ‘Crawl space walls’ and substitute to read as follows:

R402.2.11 Crawl space walls. As an alternative to insulating floors over crawl spaces, crawl space walls shall be permitted to be insulated when the crawl space is not vented to the outside. Crawl space wall insulation shall be permanently fastened to the wall and extend downward from the floor to within 9 inches (229 mm) of the finished interior grade adjacent to the foundation wall. A 3-inch (76 mm) inspection/view strip immediately below the floor joists shall be provided to permit inspections for termites. Exposed earth in unvented crawl space foundations shall be covered with a continuous Class 1 vapor retarder in accordance with the *International Building Code*. All joints of the vapor retarder shall overlap by 6 inches (152 mm) and be sealed or taped. The edges of the vapor retarder shall extend at least 6 inches (152 mm) up the stem wall and shall be attached and sealed to the stem wall.
(Effective January 1, 2020)

*Revise Section R402.3.4 ‘Opaque door exemption’ as follows:

R402.3.4 Opaque door exemption. One side-hinged opaque door assembly up to 24 square feet (2.22 m²) in area is exempted from the *U*-factor requirement in Section R402.1.4. This exemption shall not apply to Attic Access Doors or the *U*-factor alternative approach in Section R402.1.4 and the total UA alternative in Section R402.1.5.
(Effective January 1, 2020)

*Revise R402.4.1.1 ‘Installation’ to read as follows:

R402.4.1.1 Installation. The components of the building thermal envelope shall be installed in accordance with the manufacturer’s instructions and the criteria listed on page 1 of Appendix RA of the 2020 Georgia State Supplements and Amendments, as applicable to the method of construction. Where required by the *code official*, an *approved* third party shall inspect all components and verify compliance. See Appendix RA ‘AIR BARRIER AND INSULATION INSTALLATION COMPONENT GUIDE’ of these Georgia State Supplements and Amendments for a graphical representation of the items listed above.
(Effective January 1, 2020)

*Revise Section R402.4.1.2 ‘Testing’ as follows:

R402.4.1.2 Testing. All one and two-family dwelling units shall be tested and verified to less than five air changes per hour at 50 Pascals (ACH50) for Climate Zones 2, 3, and 4. Testing shall be conducted in accordance with ASTM E 779 or ASTM E 1827 or ANSI/RESNET/ICC 380 and reported at a pressure of 0.2 inch w.g. (50 Pascals). A written report of the results of the test shall be signed by the party conducting the test and provided to the *code official*. Testing shall be performed at any time after creation of all penetrations of the *building thermal envelope*. Testing shall be conducted by a *certified duct and envelope tightness (DET) verifier*.
(Remainder of section left unchanged)
(Effective January 1, 2020)

*Add a new Section R402.4.1.3 ‘Low-rise R-2 multifamily testing’ as follows:

R402.4.1.3 Low-rise R-2 multifamily testing. Low-rise R-2 multifamily dwellings shall be tested to less than 7 air changes per hour at 50 Pascals (ACH50).

As an alternative to ACH50, compliance for Low-rise R-2 dwellings may be attained by achieving an Envelope Leakage Ratio at 50 Pascals (ELR50) of less than 0.35 ($ELR50 < 0.35$, where $ELR50 = CFM50 / \text{Envelope Shell Area}$, in square feet).
(Effective January 1, 2020)

*Add a new Section R402.4.1.3.1 ‘Low-rise multifamily testing protocol (Optional)’ as follows:

R402.4.1.3.1 Low-rise multifamily testing protocol (Optional). Where a residential building is classified as R-2, envelope testing may (optionally) employ either one or both of the following testing protocols:

1. Utilize multiple fans in adjacent units (commonly referred to as Guarded Blower Door testing) to minimize effect of leakage to adjacent units (not required).
2. Envelope testing of less than 100 percent shall be acceptable assuming a maximum sampling protocol of 1 in 4 units per floor (if sampled unit passes, the remaining up to three units are deemed to comply; if sampled unit fails, it must be sealed and retested and the remaining up to three units shall also be tested).

(Effective January 1, 2020)

SECTION R403 SYSTEMS

*Revise Section R403.1.2 ‘Heat pump supplementary heat (Mandatory)’ to add a new sentence at the end to read as follows:

R403.1.2 Heat pump supplementary heat (Mandatory). Heat pumps having supplementary electric-resistance heat shall have controls that, except during defrost, prevent supplemental heat operation when the heat pump compressor can meet the heating load. Except in emergency heating mode, the supplementary electric-resistance heat in heat pump systems installed in new construction may not energize unless the outdoor temperature is below 40° F (4°C).
(Effective January 1, 2020)

*Add new Section R403.1.2.3 ‘Primary heat source’ to read as follows:

R403.1.2.3 Primary heat source. For new dwelling unit central HVAC systems, or replacement HVAC systems installed in dwelling units that were originally permitted after January 1, 1996, electric-resistance heat shall not be used as the primary heat source. Primary heat source is defined as the heat source for the original dwelling unit system.
(Effective January 1, 2020)

*Revise Section R403.3.2 ‘Sealing (Mandatory)’ as follows:

R403.3.2 Sealing (Mandatory). Ducts, air handlers and filter boxes shall be sealed. Joints and seams shall comply with Section R403.3.6 of these Georgia State Supplements and Amendments.

Exceptions:

1. Air-impermeable spray foam product shall be permitted to be applied without additional joint seals.
2. For ducts having a static pressure classification of less than 2 inches of water column (500 Pa), additional closure systems shall not be required for continuously welded joints and seams, and locking-type joints and seams of other than the snap-lock and button-lock types.
3. Where a duct connection is made that is partially inaccessible, three screws or rivets shall be equally spaced on the exposed portion of the joint so as to prevent a hinge effect.
4. Sealing that would void product listings is not required.

*Revise Section R403.3.3 ‘Duct testing (Mandatory)’ as follows:

R403.3.3 Duct testing (Mandatory). Ducts shall be pressure tested to determine air leakage by one of the following methods:

1. Rough-in test: Total leakage shall be measured with a pressure differential of 0.1 inch w.g. (25 Pa) across the system, including the manufacturer’s air handler enclosure. All registers shall be taped or otherwise sealed during the test.
2. Post-construction test: Total leakage shall be measured with a pressure differential of 0.1 inch w.g. (25 Pa) across the entire system, including the manufacturer’s air handler enclosure. Registers shall be taped or otherwise sealed during the test.

Exceptions:

1. A duct air leakage test shall not be required where the ducts and air handlers are located entirely within the building thermal envelope.
2. Duct tightness testing is not required for existing duct systems unless more than 50% of the duct system is modified.
3. If the air handler, furnace or evaporator coil is replaced on an existing system, all joints, seams and connections from equipment to duct system and duct system connections to plenums within 5 feet from the new work shall meet the sealing requirements of this code and be verified by a visual inspection by the state licensed conditioned air contractor or by a DET Verifier.

A report of the results of the test shall be signed by the party conducting the test and provided to the owner or the owner’s agent and, if requested, to the *code official*.
(Effective January 1, 2020)

*Revise Section R403.3.4 ‘Duct leakage (Prescriptive)’ as follows:

R403.3.4 Duct leakage (Mandatory). The total leakage of the ducts, where measured by one of the following methods in accordance with Section R403.3.3 shall be as follows:

1. Rough-in test: The total leakage shall be less than or equal to 6 cubic feet per minute (113.3 L/min) per 100 square feet (9.29 m²) of conditioned floor area where the air handler is installed at the time of the test.
2. Post-construction test: Total leakage shall be less than or equal to 6 cubic feet per minute (113.3 L/min) per 100 sq. feet (9.29 m²) of conditioned floor area.

Exceptions:

1. A duct air leakage test shall not be required where the ducts and air handlers are located entirely within the building thermal envelope.
2. Duct tightness testing is not required for existing duct systems unless more than 50% of the duct system is modified.
3. If the air handler, furnace or evaporator coil is replaced on an existing system, all joints, seams and connections from equipment to duct system and duct system connections to plenums within 5 feet from the new work shall meet the sealing requirements of this code and be verified by a visual inspection by the state licensed conditioned air contractor or by a DET Verifier.

(Effective January 1, 2020)

*Add a new Section R403.3.6 ‘Joints, seams and Connections’ as follows:

R403.3.6 Joints, seams and Connections. All longitudinal and transverse joints, seams and connections in metallic and nonmetallic ducts shall be constructed as specified in *SMACNA HVAC Duct Construction Standards- Metal and Flexible* and *NAIMA Fibrous Glass Duct Construction Standards*. All joints, longitudinal and transverse seams, and connections in ductwork shall be securely fastened and sealed with welds, gaskets, mastics (adhesives), mastic-plus-embedded-fabric systems or tapes. Without exception all closure systems shall have mastic applied that is at least 0.08 inches (2 mm) thick.

Closure systems used to seal flexible air ducts and flexible air connections shall comply with UL 181B and shall be marked “181B-FX” for pressure-sensitive tape or “181B-M” for mastic. Duct connections to flanges of air distribution systems equipment shall be sealed and mechanically fastened. Mechanical fasteners for use with flexible non-metallic air ducts shall comply with UL 181B and shall be marked 181B-C. Crimp joints for round metallic ducts shall have a contact lap of not less than 1 inch (25.4 mm) and shall be mechanically fastened by means of not less than three sheet-metal screws or rivets equally spaced around the joint.

Closure systems used to seal metal ductwork shall be installed in accordance with manufacturer’s instructions. Round metallic ducts shall be mechanically fastened by means of at least three sheet metal screws or rivets spaced equally around the joint. Unlisted duct tape shall not be permitted as a sealant on any duct.

Exceptions:

1. Spray polyurethane foam shall be permitted to be applied without additional joint seals.
2. Where a duct connection is made that is partially inaccessible, three screws or rivets shall be equally spaced on the exposed portion of the joint so as to prevent a hinge effect.
3. Continuously welded and locking-type longitudinal joints and seams in ducts operating at static pressure less than 2 inches (51 mm) of water column (500 Pa) pressure classification shall not require additional closure systems.

(Effective January 1, 2020)

*Revise Section R403.5.4 ‘Drain water heat recovery units’ to read as follows:

R403.5.4 Drain water heat recovery units. Drain water heat recovery units shall comply with CSA B55.2 or IAPMO PS 92. Vertical drain water heat recovery units shall be tested in accordance with CSA B55.1 and have a minimum effectiveness of 42 percent when tested in accordance with CSA B55.1. Sloped drain water heat recovery units shall be tested in accordance with IAPMO IGC 346 and have a minimum rated effectiveness of 42 percent when tested in accordance with IAPMO IGC 346 at the minimum slope specified in the Georgia plumbing code. Potable water-side pressure loss of vertical drain water heat recovery units shall be less than 3 psi (20.7 kPa) for individual units connected to one or two showers. Potable water-side pressure loss of vertical drain water heat recovery units shall be less than 2 psi (13.8 kPa) for individual units connected to three or more showers. Potable water-side pressure loss of sloped drain water heat recovery units shall be less than 4 psi (20.7 kPa).

(Effective January 1, 2020)

*Revise Section R403.6 ‘Mechanical Ventilation’ to read as follows:

R403.6 Mechanical ventilation (Mandatory). Where required, the building shall be provided with ventilation that meets the requirements of the *International Residential Code* or *International Mechanical Code*, as applicable, or with ASHRAE 62.2-2016, *Ventilation and Acceptable Indoor Air Quality in Low-Rise Residential Buildings* (in entirety) or with other approved means of ventilation. Outdoor air intakes and exhausts shall have automatic or gravity dampers that close when the ventilation system is not operating.

(Remainder of section left unchanged)

(Effective January 1, 2020)

*Revise Section R403.7 ‘Equipment sizing and efficiency rating (Mandatory)’ by adding the following sentence at the end:

R403.7 Equipment sizing and efficiency rating (Mandatory). (The beginning of the section left unchanged) For automatically modulating capacity heating and cooling equipment, the system shall be deemed to comply with appropriate portions of Manual S provided the lowest output capacity of the equipment is less than the peak design load as determined by Manual J.

(Effective January 1, 2020)

*Add new Section R403.13 ‘Power attic ventilators’ to read as follows:

R403.13 Electric powered attic ventilators. In new construction, electric powered attic ventilators shall not be connected to the Service supply premise wiring system. Solar photovoltaic (PV) powered attic ventilators shall be permitted. (Effective January 1, 2020)

**SECTION R406
ENERGY RATING INDEX
COMPLIANCE ALTERNATIVE**

*Revise Section R406.3 ‘Energy Rating Index’ as follows:

R406.3 Energy Rating Index. The Energy Rating Index (ERI) shall be determined in accordance with ANSI/RESNET/ICC 301 except for buildings constructed in accordance with the International Residential Code, where the ERI reference design ventilation rate shall be in accordance with the following:

$$\text{Ventilation rate} = (0.01 \times \text{total square foot area of house}) + (7.5 (N_{br} + 1))$$

Equation 4-1

where,

Ventilation rate is defined in units of cubic feet per
minute N_{br} = Number of bedrooms

The ERI shall consider all energy used in the *residential building* including *on-site renewable energy*. Energy used to recharge or refuel a vehicle for on-road (and off-site) transportation purposes shall not be included in the ERI *reference design* or the *rated design*. (Effective January 1, 2020)

*Delete Section R406.3.1 ‘ERI reference design’ without substitution. (Effective January 1, 2020)

*Revise Table R406.4 ‘MAXIMUM ENERGY RATING INDEX’ as follows:

**TABLE R406.4
MAXIMUM ENERGY RATING INDEX**

CLIMATE ZONE	ENERGY RATING INDEX
2	57
3	57
4	62

(Effective January 1, 2020)

*Revise Section R406.6.1 ‘Compliance software tools’ as follows:

R406.6.1 Compliance software tools. The ERI shall be determined using Approved Software Rating Tools in accordance with ANSI/RESNET/ICC 301.
(Effective January 1, 2020)

*Delete Section R406.7 ‘Calculation software tools’ without substitution.
(Effective January 1, 2020)

*Delete Section R406.7.1 ‘Minimum capabilities’ without substitution.
(Effective January 1, 2020)

*Revise and rename Section R406.7.2 ‘Specific approval’ as follows:
(Effective January 1, 2020)

R406.6.4 Specific approval. Performance analysis tools meeting the applicable sections of Section R406 shall be *approved*. Documentation demonstrating the approval of performance analysis tools in accordance with Section R406.6.1 shall be provided to the *code official*. The *code official* shall approve tools for a specified application or limited scope.
(Effective January 1, 2020)

*Revise and rename Section R406.7.3 ‘Input values’ as follows:

R406.6.5 Input values. Where calculations require input values not specified by Sections R402, R403, R404 and R405, those input values shall be taken from ANSI/RESNET/ICC 301.
(Effective January 1, 2020)

**CHAPTER 5 [RE]
EXISTING BUILDINGS**

**SECTION R502
ADDITIONS**

*Revise Section R502.1.1.2 'Heating and cooling systems' to delete the exception and substitute to read as follows:

R502.1.1.2 Heating and cooling systems. New heating, cooling and duct systems that are part of the addition shall comply with Sections R403.1, R403.2, R403.3, R403.5 and R403.6.

Exception: Duct tightness testing is not required for existing duct systems unless more than 50% of the existing duct system is modified.

(Effective January 1, 2020)

**SECTION R503
ALTERATIONS**

*Revise Section R503.1.2 'Heating and cooling systems' as follows:

R503.1.2 Heating and cooling systems. New heating, cooling and duct systems that are part of the alteration shall comply with Sections R403.1, R403.2, R403.3 and R403.6.

Exception: Duct tightness testing is not required for existing duct systems unless more than 50% of the existing duct system is modified.

(Effective January 1, 2020)

**CHAPTER 6 [RE]
REFERENCED STANDARDS**

*Revise Chapter 6 ‘Referenced Standards’ to add the following new Standards to read as follows:

UL		
	UL LLC 333 Pfingsten Road Northbrook, IL 60062-2096	
Standard reference number	Title	Referenced in code section number
181 - 2013	Factory-made Air Ducts and Air Connectors—with Revisions through May 2003	R403.3.6
181A - 2013	Closure Systems for Use with Rigid Air Ducts and Air Connectors—with Revisions through December 1998	R403.3.6
181B - 2013	Closure Systems for Use with Flexible Air Ducts and Air Connectors—with Revisions through August 2003	R403.3.6
ASHRAE		
	American Society of Heating, Refrigerating and Air-Conditioning Engineers, Inc. 1791 Tullie Circle, NE Atlanta, GA 30329-2305	
Standard reference number	Title	Referenced in code section number
ASHRAE 62.2 – 2016	Ventilation and Acceptable Indoor Air Quality in Low- Rise Residential Buildings	R403.6
ANSI/RESNE T/ICC 301		
	Residential Energy Services Network, Inc. P.O. Box 4561. Oceanside, CA 92052-4561 International Code Council, 500 New Jersey Avenue, NW, 6th Floor. Washington, D.C. 20001	
Standard reference number	Title	Referenced in code section number
<u>ANSI/RESNET/ICC 301-2014</u>	Standard for the Calculation and Labeling of the Energy Performance of Low-Rise Residential Buildings using an Energy Rating Index	R406
IAPMO PS 92		
	IAPMO 4755 E. Philadelphia St. Ontario, CA 91761 – USA	
Standard reference number	Title	Referenced in code section number
IAPMO PS 92-2013	Heat Exchangers and Indirect Water Heaters	R403.5.4
IAPMO IGC 346	Test Method for Measuring the Performance of Drain Water Heat Recovery Units	R403.5.4

(Standards not listed to remain unchanged)

APPENDICES

Throughout these appendices there is information that may be helpful in meeting and understanding the *Georgia State Minimum Standard Energy Code*. In cases of conflict, refer to the *2015 International Energy Conservation Code* for clarification.

APPENDIX RA

*Delete APPENDIX RA ‘RECOMMENDED PROCEDURE FOR WORST-CASE TESTING OF ATMOSPHERIC VENTING SYSTEMS UNDER R402.4 OR R405 CONDITIONS $\leq 5ACH50'$ ’, entirely and substitute with new APPENDIX RA ‘AIR SEALING KEY POINTS’.
(Effective January 1, 2020)

APPENDIX RC

*Add new APPENDIX RC ‘THIRD PARTY VERIFICATION’.
(Effective January 1, 2020)

APPENDIX RD

*Add new APPENDIX RD ‘MANDATORY COMPLIANCE CERTIFICATE’.
(Effective January 1, 2020)

The above referenced form, Mandatory Compliance Certificate is available to download for free from DCA’s webpage located at: <https://dca.ga.gov/node/3522/documents/2090>

End of Supplements and Amendments.

Appendix RA

Air Sealing and Insulation Key Points

Air Barrier and Insulation Installation Component Guide

	COMPONENT	AIR BARRIER CRITERIA	INSULATION INSTALLATION CRITERIA
1	General requirements	A continuous air barrier shall be installed in the building envelope. The exterior thermal envelope contains a continuous air barrier. Breaks or joints in the air barrier shall be sealed.	Air-permeable insulation shall not be used as a sealing material.
2	Ceiling/attic	The air barrier in any dropped ceiling/soffit shall be aligned with the insulation and any gaps in the air barrier shall be sealed. Access openings, drop down stairs or knee wall doors to unconditioned attic spaces shall be sealed.	The insulation in any dropped ceiling/soffit shall be aligned with the air barrier.
3	Walls	The junction of the foundation and sill plate shall be sealed. The junction of the top plate and the top of exterior walls shall be sealed. Knee walls shall be sealed.	Cavities within corners and headers of frame walls shall be insulated by completely filling the cavity with a material having a thermal resistance of R-3 per inch minimum. Exterior thermal envelope insulation for framed walls shall be installed in substantial contact and continuous alignment with the air barrier.
4	Windows, skylights and doors	The space between window/door jambs and framing, and skylights and framing shall be sealed.	
5	Rim joists	Rim joists shall include the air barrier.	Rim joists shall be insulated.
6	Floors (including above garage and cantilevered floors)	The air barrier shall be installed at any exposed edge of insulation.	Floor framing cavity insulation shall be installed to maintain permanent contact with the underside of subfloor decking, or floor framing cavity insulation shall be permitted to be in contact with the top side of sheathing, or continuous insulation installed on the underside of floor framing and extends from the bottom to the top of all perimeter floor framing members.
7	Crawl space walls	Exposed earth in unvented crawl spaces shall be covered with a Class I vapor retarder with overlapping joints taped.	Where provided instead of floor insulation (unvented crawl spaces), insulation shall be permanently attached to the crawlspace walls.
8	Shafts, penetrations	Duct shafts, utility penetrations, and flue shafts opening to exterior or unconditioned space shall be sealed.	Capped chases shall be insulated to surrounding ceiling R-values (maintain clearance from combustion flues).
9	Narrow cavities		Batts in narrow cavities shall be cut to fit, or narrow cavities shall be filled by insulation that on installation readily conforms to the available cavity space.
10	Garage separation	Air sealing shall be provided between the garage and conditioned spaces.	Band area shall be blocked, sealed and insulated.
11	Recessed lighting	Recessed light fixtures installed in the building thermal envelope shall be sealed to the drywall.	Recessed light fixtures installed in the building thermal envelope shall be air tight and IC rated.
12	Plumbing and wiring	Wiring and plumbing penetrations shall be sealed.	Batt insulation shall be cut neatly to fit around wiring and plumbing in exterior walls, or insulation that on installation readily conforms to available space shall extend behind piping and wiring.
13	Shower/tub on exterior wall	The air barrier installed at exterior walls adjacent to showers and tubs shall separate them from the showers and tubs.	Exterior walls adjacent to showers and tubs shall be insulated.
14	Electrical/phone box on exterior walls	The air barrier shall be installed behind electrical or communication boxes or air-sealed boxes shall be installed.	
15	HVAC register boots	HVAC register boots shall be sealed to the subfloor or drywall.	Boots in unconditioned spaces shall be insulated. Recommend insulating boots in conditioned spaces for condensation control.
16	Concealed sprinklers	When required to be sealed, concealed fire sprinklers shall only be sealed in a manner that is recommended by the manufacturer. Caulking or other adhesive sealants shall not be used to fill voids between fire sprinkler cover plates and walls or ceilings.	
17	Blocking between framing (e.g. beneath knee walls, cantilevered floors, garage separation walls)	Blocking shall be sealed to framing.	Insulation shall be in contact with blocking.
18	Common walls	Air barrier is installed in common wall between dwelling units.	
19	Fireplaces	New wood-burning fireplaces shall have tight-fitting flue dampers or doors, and outdoor combustion air.	Fireplace chase insulation shall be restrained to stay in place.

Disclaimer: This document was created by Southface and is intended solely to help graphically demonstrate the air leakage and insulation provisions of the 2015 IECC (2020 Georgia Energy Code). It does not cover all air sealing locations, materials or techniques. Other code provisions may be applicable as well.

Air sealing key points

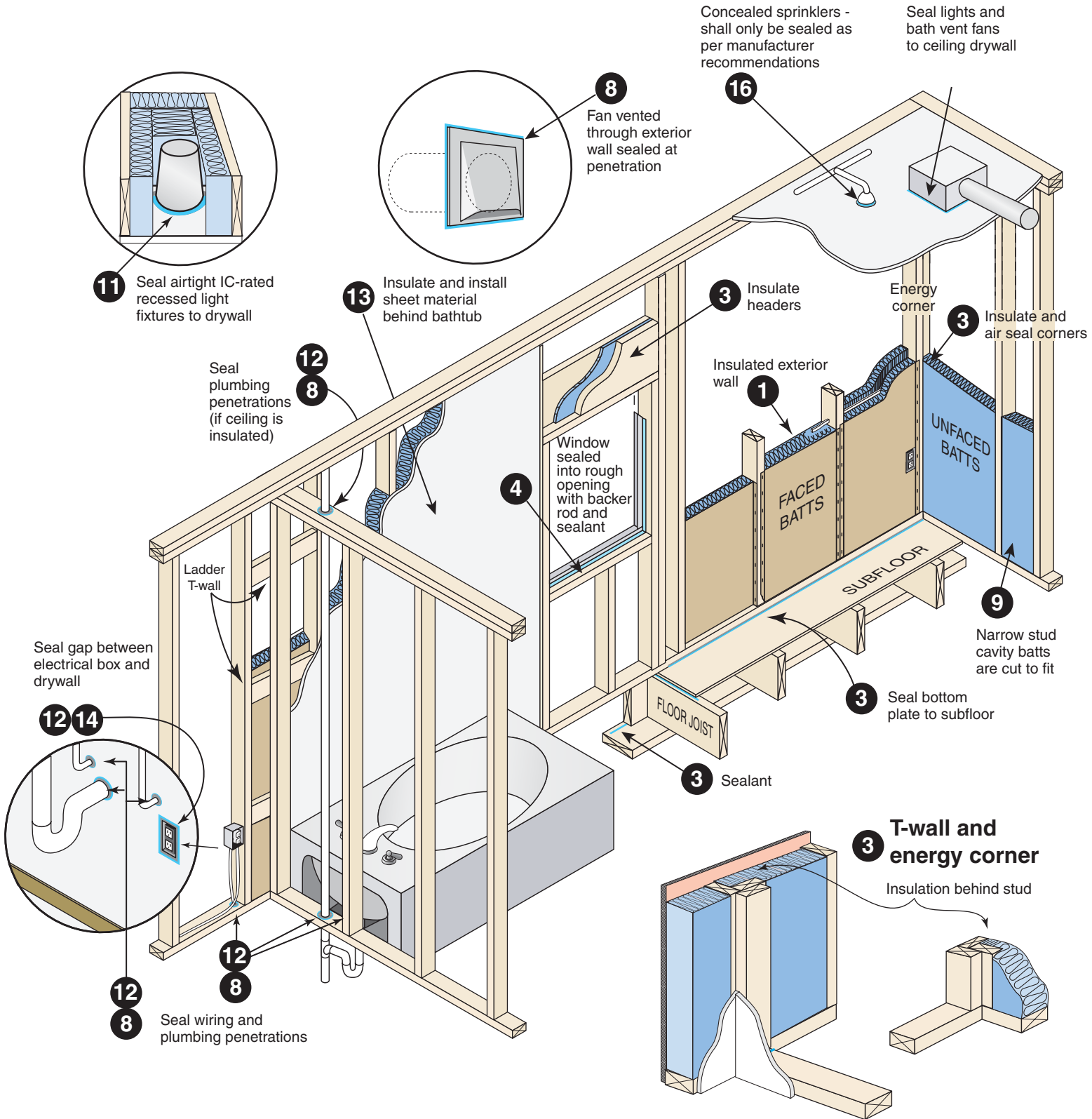

Disclaimer:
 This document was created by Southface and is intended solely to help graphically demonstrate the air leakage and insulation provisions of the 2015 IECC (2020 Georgia Energy Code). It does not cover all air sealing locations, materials or techniques. Other code provisions may be applicable as well.

Air sealing key points *continued*

Chases and common by-passes

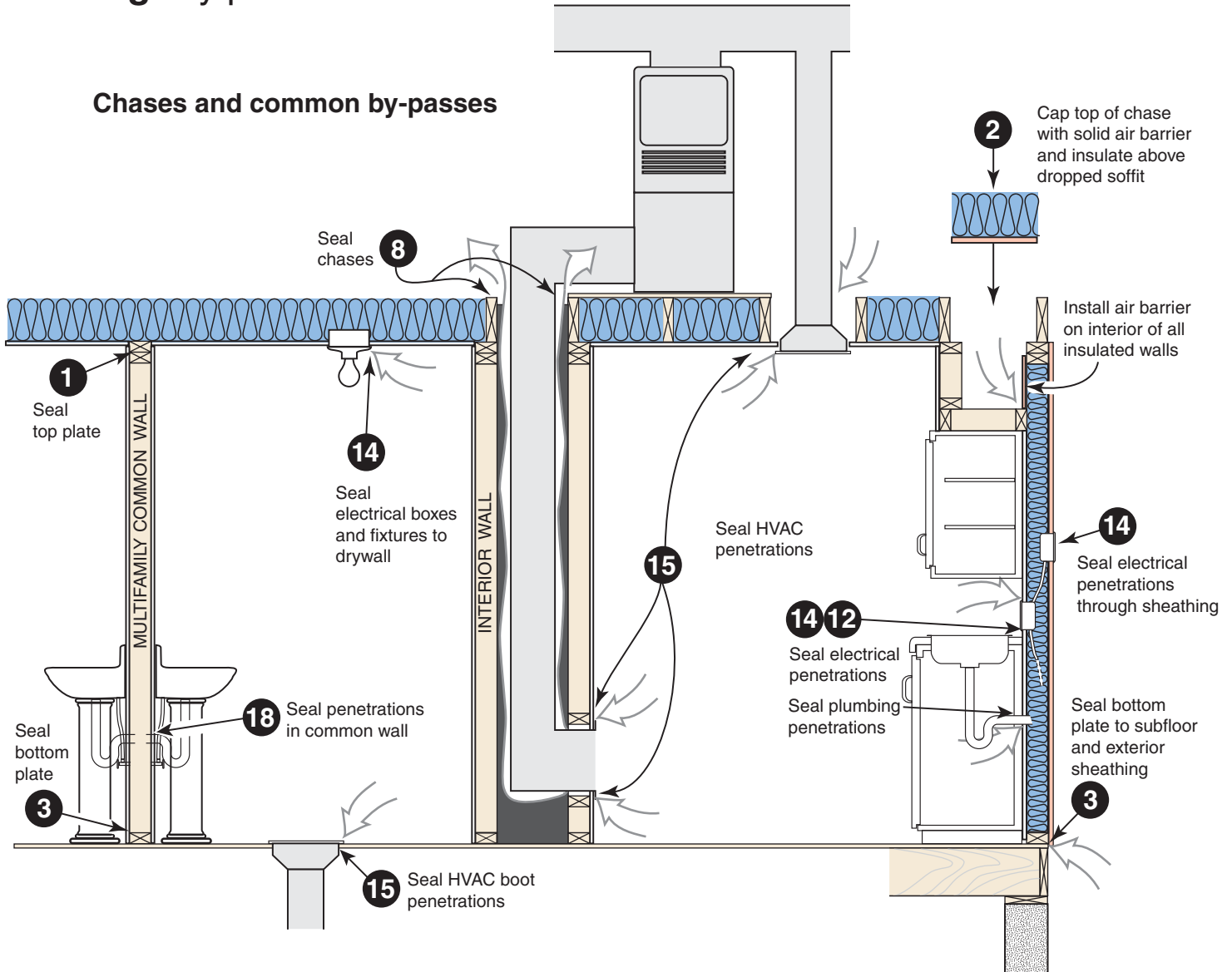

Shower/tub drain rough opening

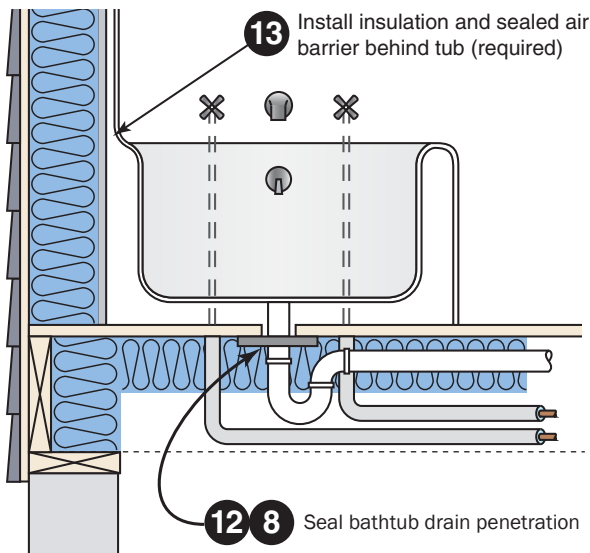

Electrical panel box, recommend install on interior (non-insulated) wall. If installed on exterior wall, air barrier shall extend behind box or air-sealed box shall be installed.

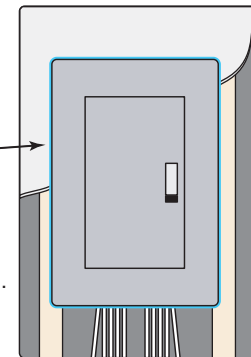

Disclaimer:
This document was created by Southface and is intended solely to help graphically demonstrate the air leakage and insulation provisions of the 2015 IECC (2020 Georgia Energy Code). It does not cover all air sealing locations, materials or techniques. Other code provisions may be applicable as well.

Air sealing key points *continued*

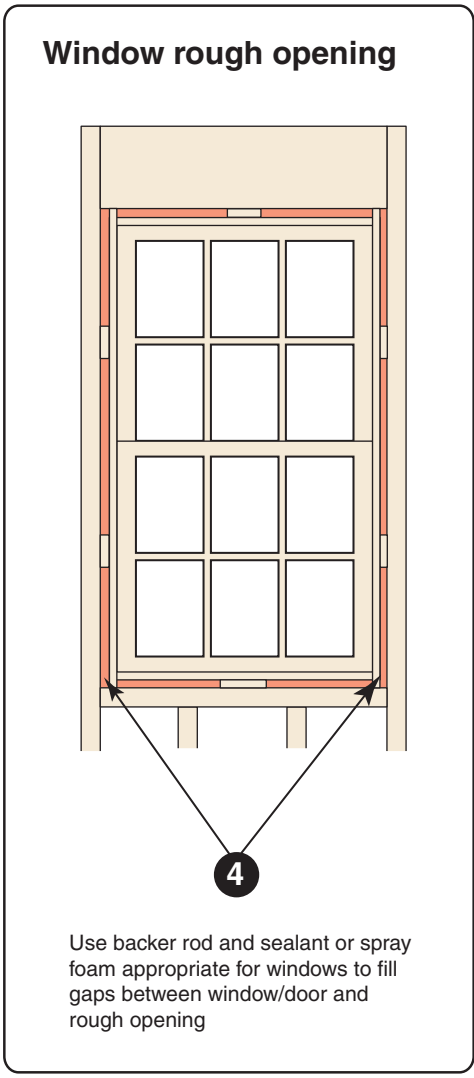

Wall cross-section

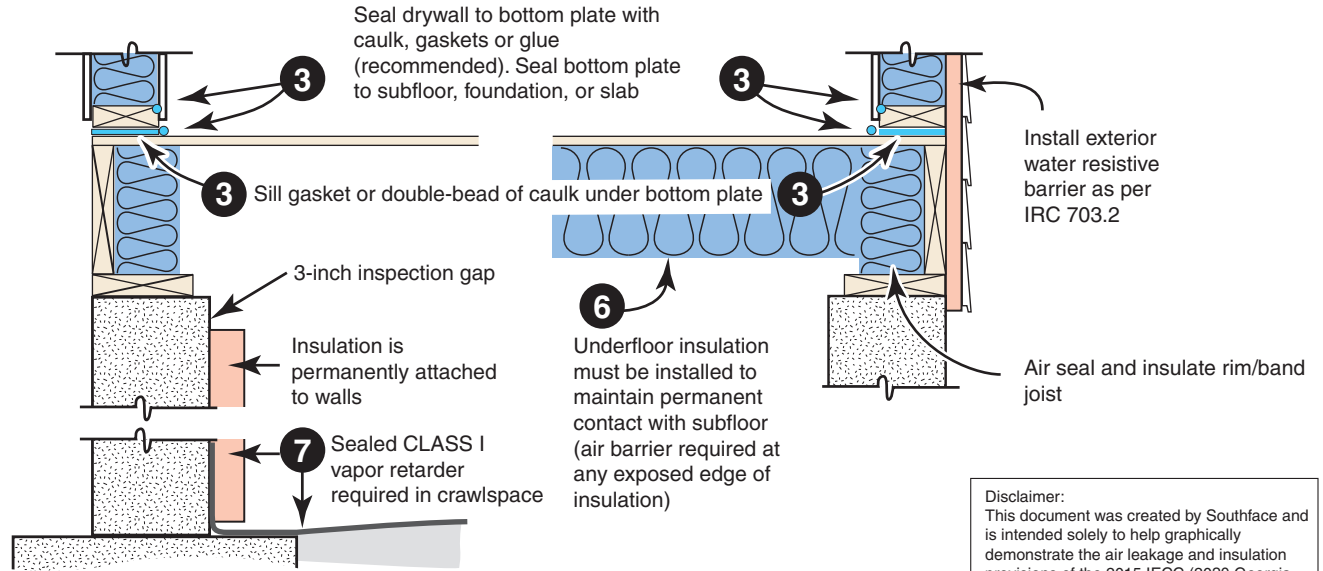
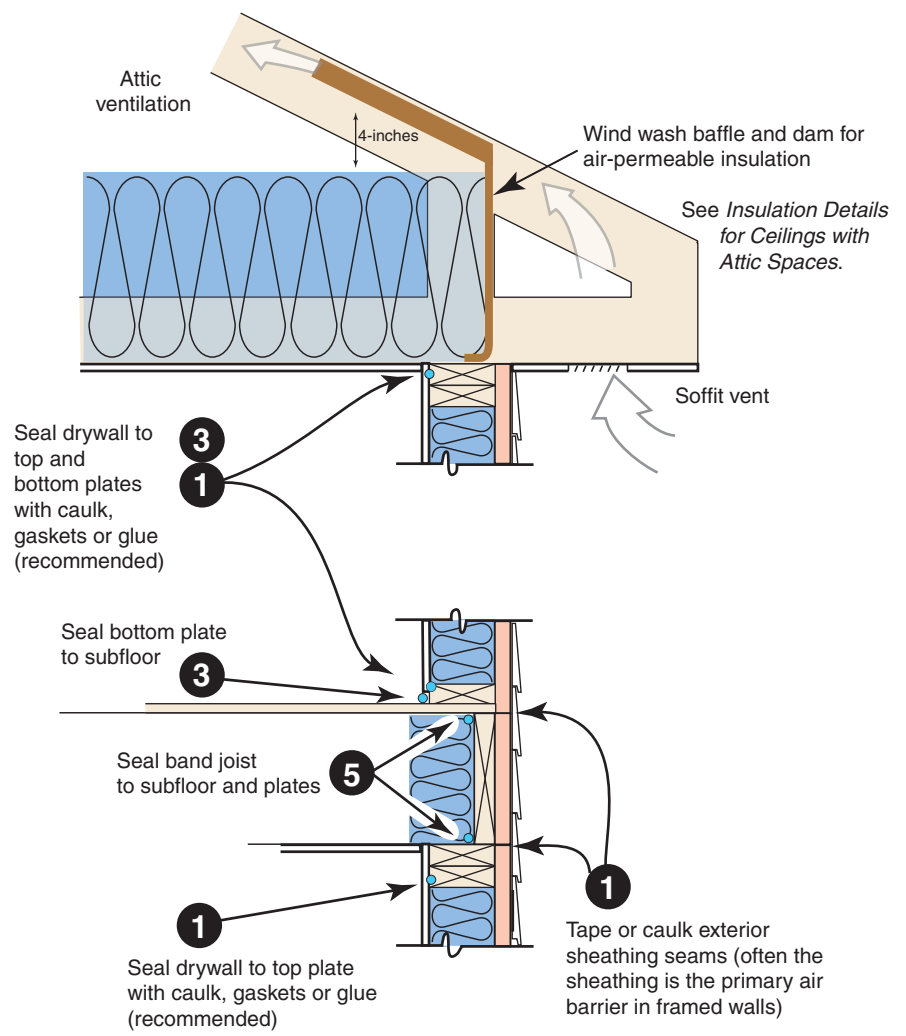

Disclaimer:
 This document was created by Southface and is intended solely to help graphically demonstrate the air leakage and insulation provisions of the 2015 IECC (2020 Georgia Energy Code). It does not cover all air sealing locations, materials or techniques. Other code provisions may be applicable as well.

Air sealing key points *continued*

Combustion chase penetrations

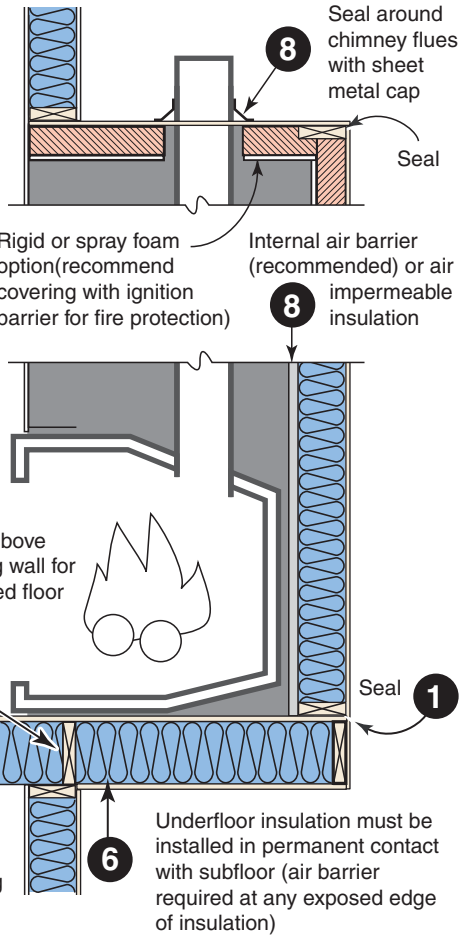

Combustion closet

Combustion air inlets
as per mechanical and/or fuel gas code

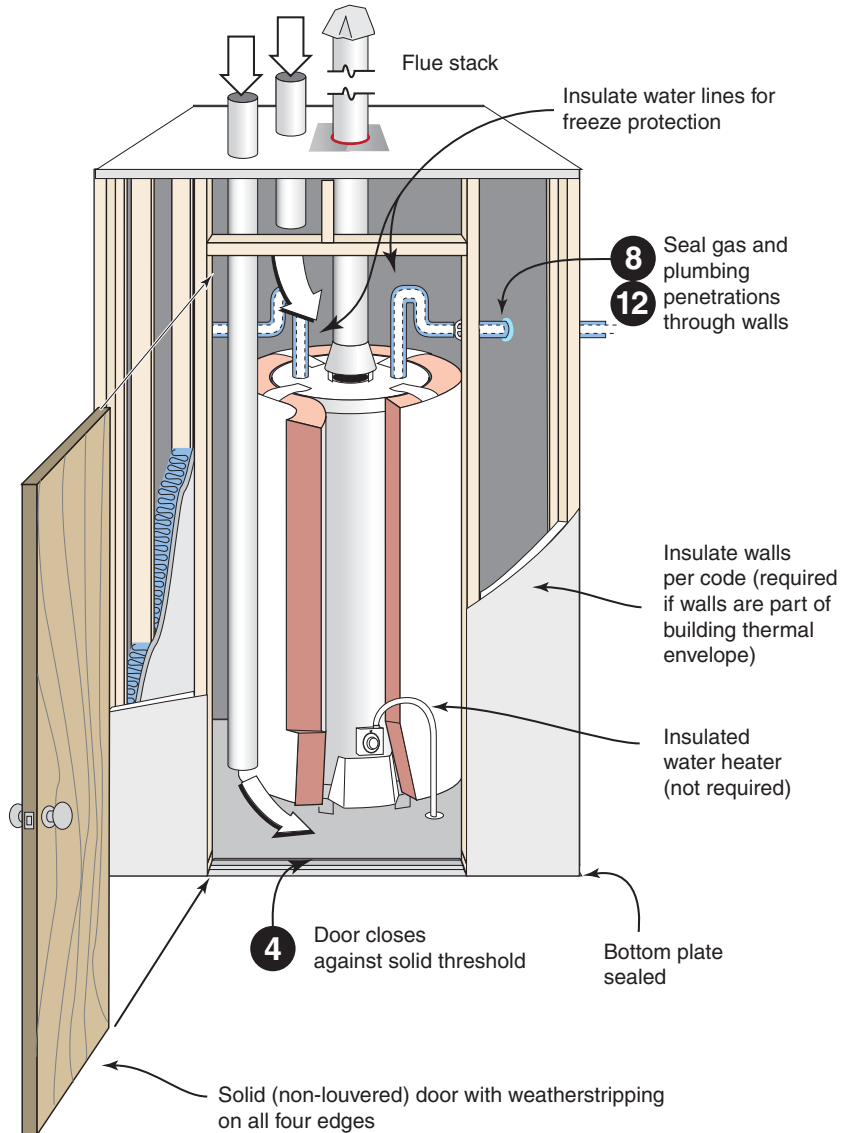

Exterior penetrations

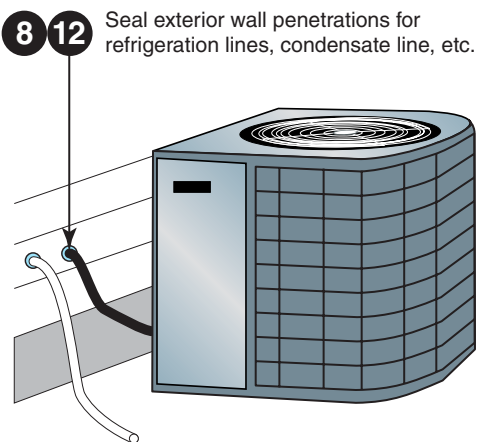

Disclaimer:
This document was created by Southface and is intended solely to help graphically demonstrate the air leakage and insulation provisions of the 2015 IECC (2020 Georgia Energy Code). It does not cover all air sealing locations, materials or techniques. Other code provisions may be applicable as well.

Air sealing key points *continued*

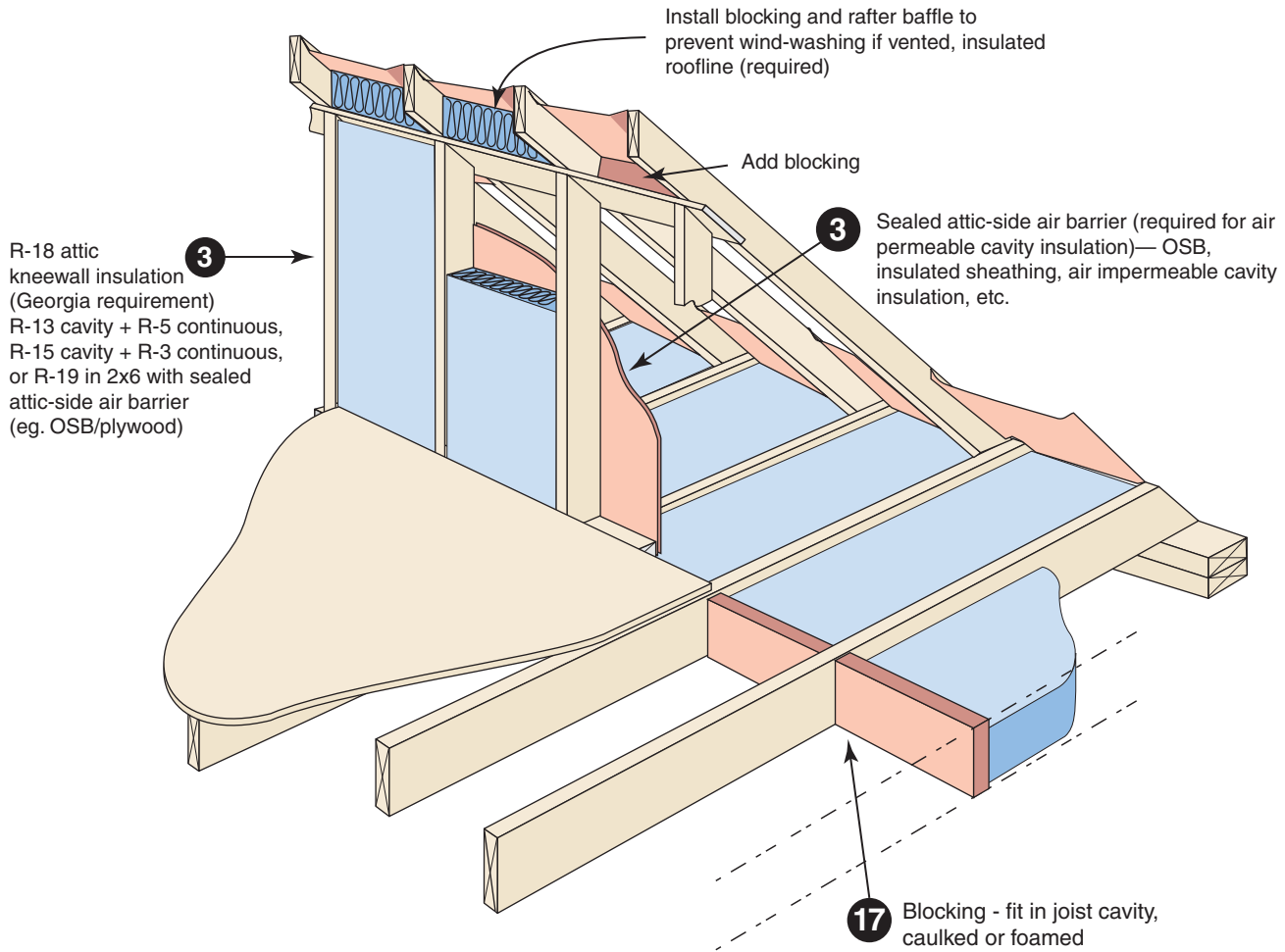

Attic knee-walls

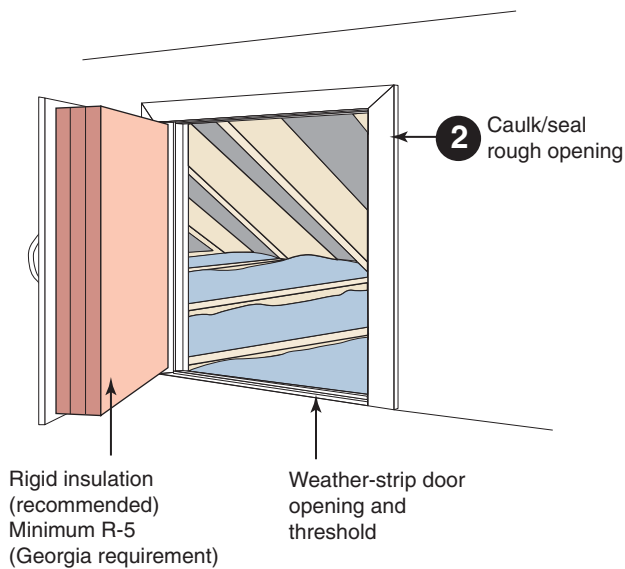

Two-level attic

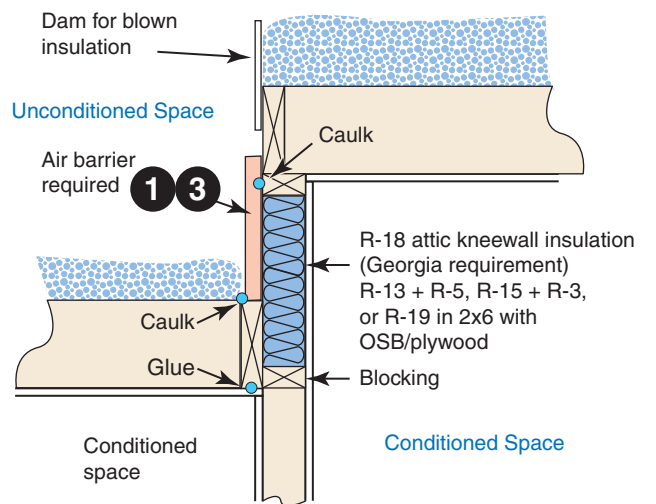

Disclaimer:
This document was created by Southface and is intended solely to help graphically demonstrate the air leakage and insulation provisions of the 2015 IECC (2020 Georgia Energy Code). It does not cover all air sealing locations, materials or techniques. Other code provisions may be applicable as well.

Air sealing key points *continued*

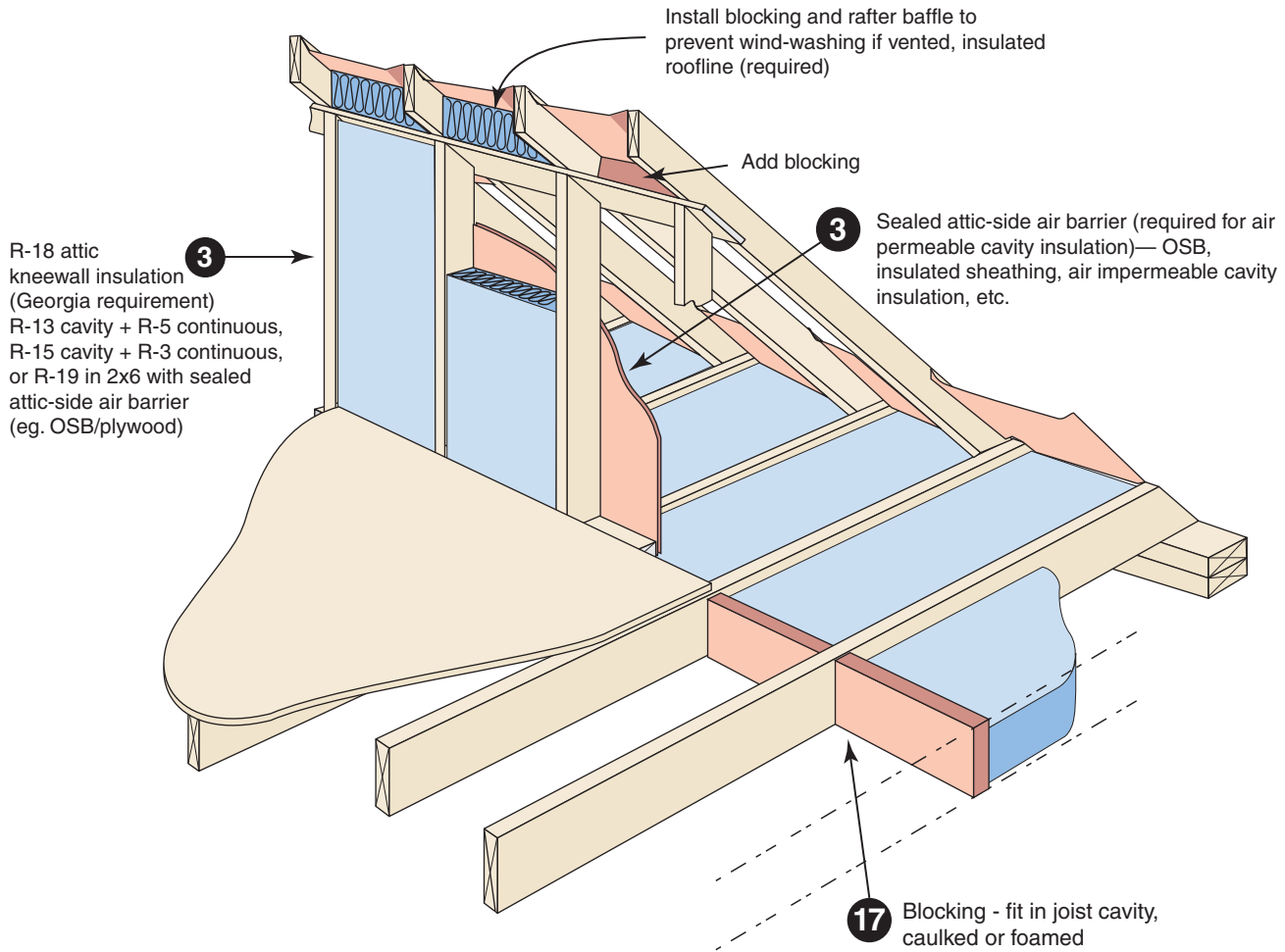

Attic knee-walls

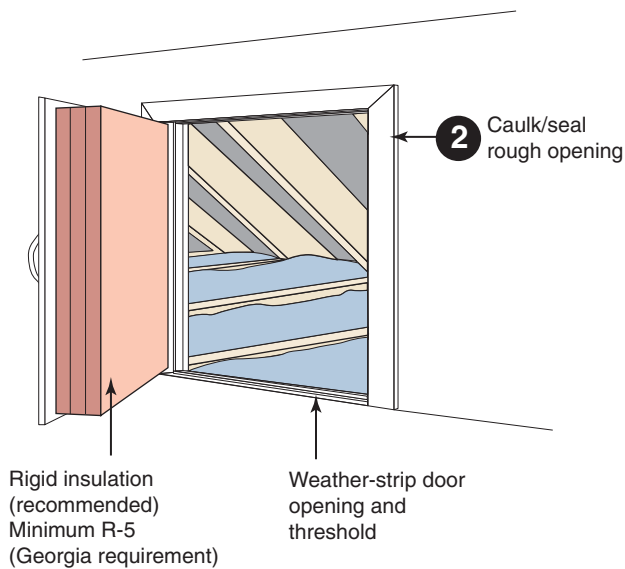

Two-level attic

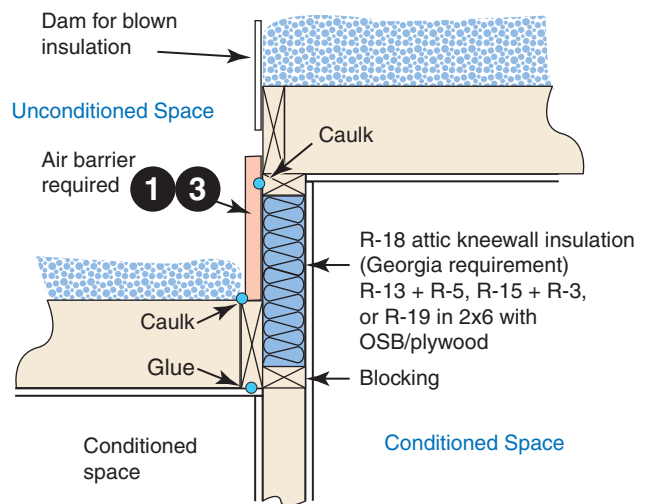

Disclaimer:
This document was created by Southface and is intended solely to help graphically demonstrate the air leakage and insulation provisions of the 2015 IECC (2020 Georgia Energy Code). It does not cover all air sealing locations, materials or techniques. Other code provisions may be applicable as well.

Air sealing key points *continued*

Attic scuttle

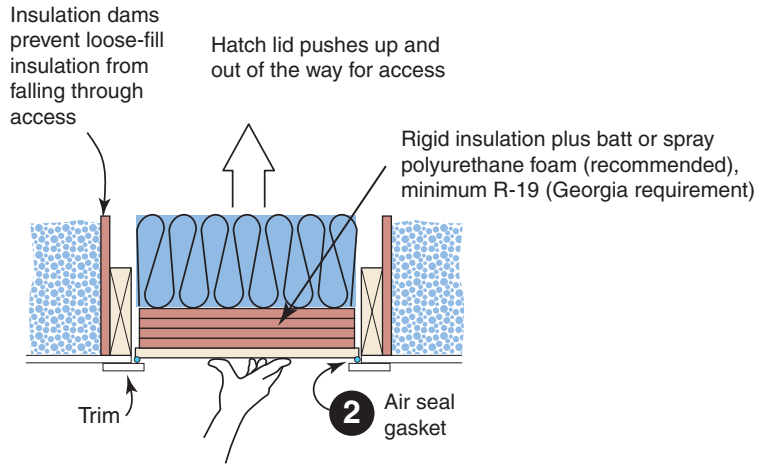

Attic pull-down stairs

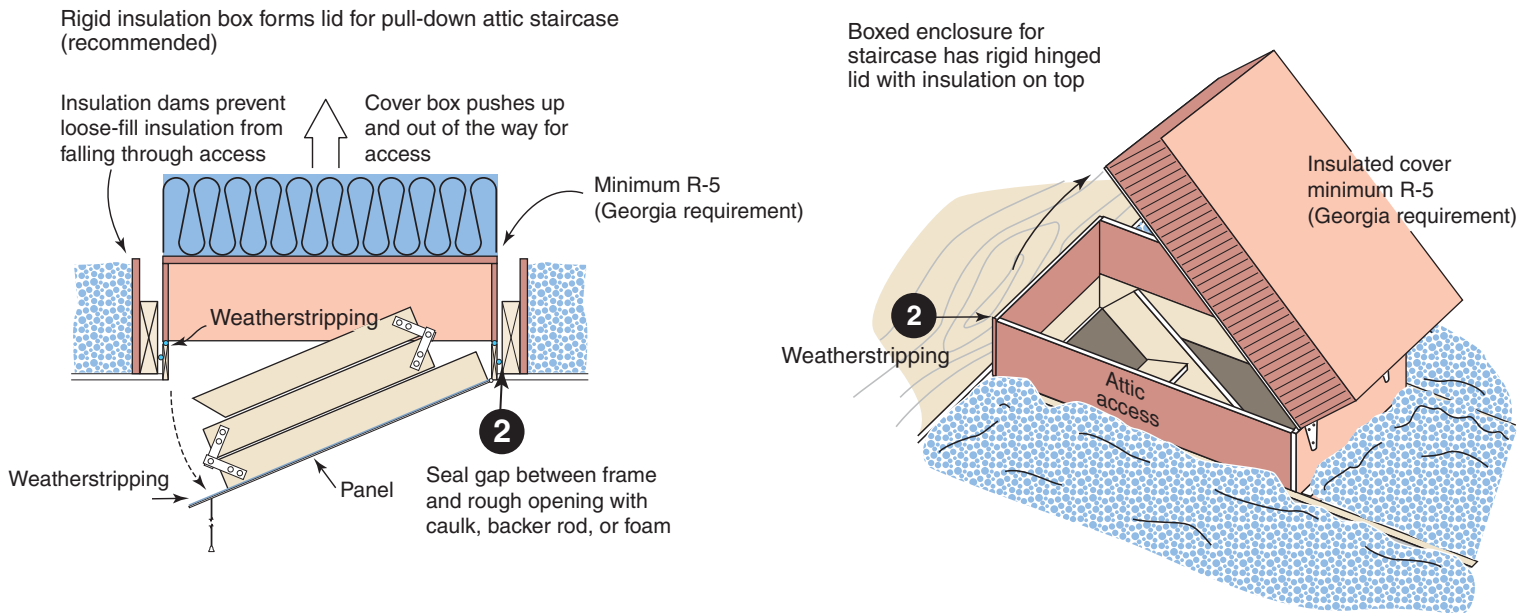

Attic pull-down stairs

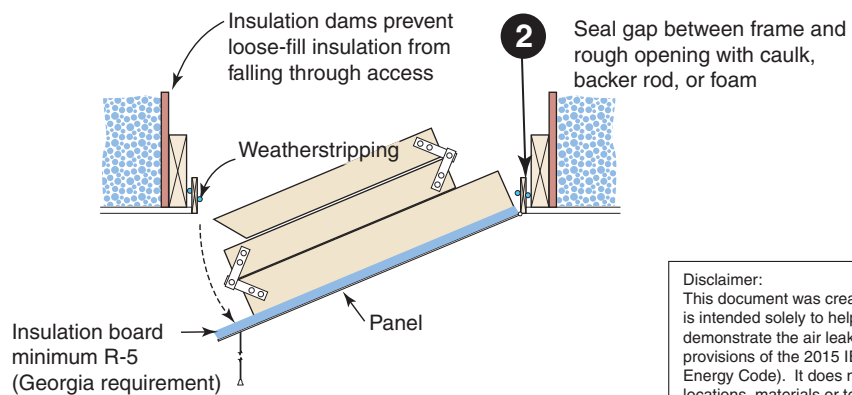

Disclaimer:
 This document was created by Southface and is intended solely to help graphically demonstrate the air leakage and insulation provisions of the 2015 IECC (2020 Georgia Energy Code). It does not cover all air sealing locations, materials or techniques. Other code provisions may be applicable as well.

Air sealing key points *continued*

Attic scuttle

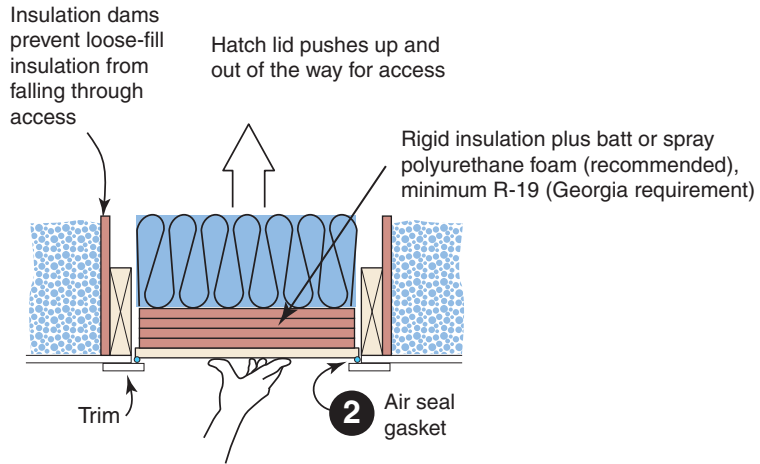

Attic pull-down stairs

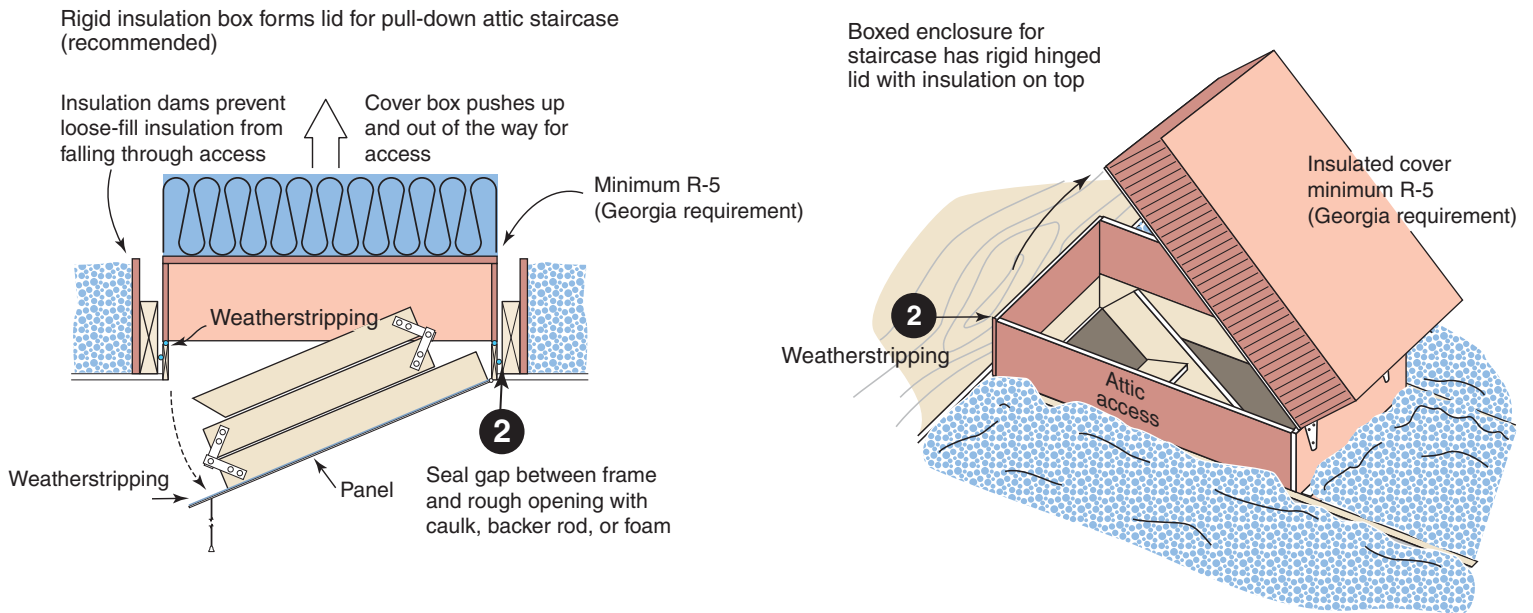

Attic pull-down stairs

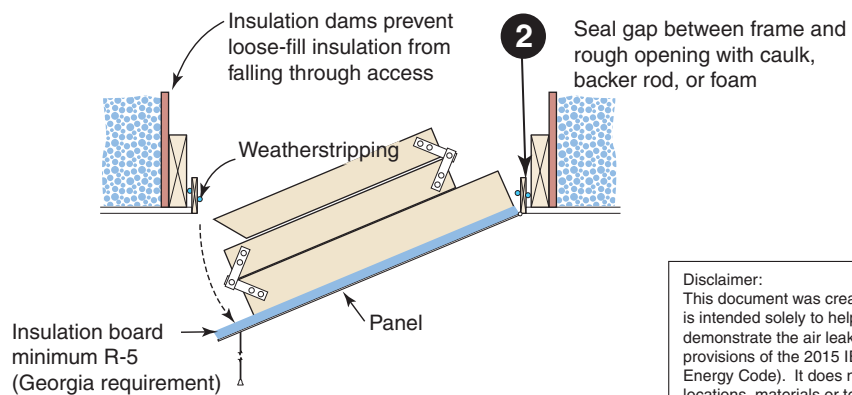

Disclaimer:
This document was created by Southface and is intended solely to help graphically demonstrate the air leakage and insulation provisions of the 2015 IECC (2020 Georgia Energy Code). It does not cover all air sealing locations, materials or techniques. Other code provisions may be applicable as well.

Garage blocking and sealing key points

Blocking, air sealing and insulation required above garage separation wall

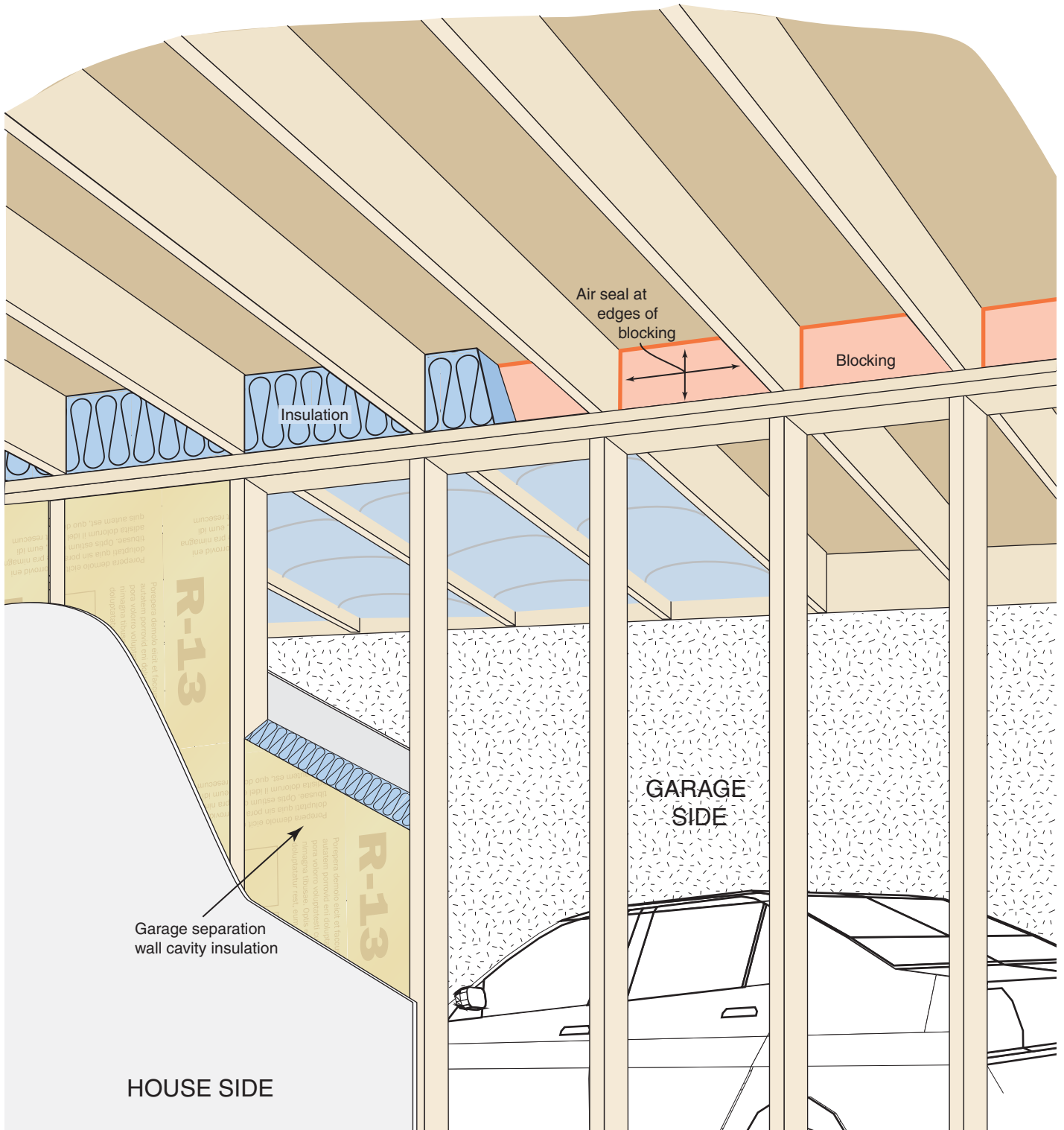

Disclaimer:
This document was created by Southface and is intended solely to help graphically demonstrate the air leakage and insulation provisions of the 2015 IECC (2020 Georgia Energy Code). It does not cover all air sealing locations, materials or techniques. Other code provisions may be applicable as well.

Air sealing key points *continued*

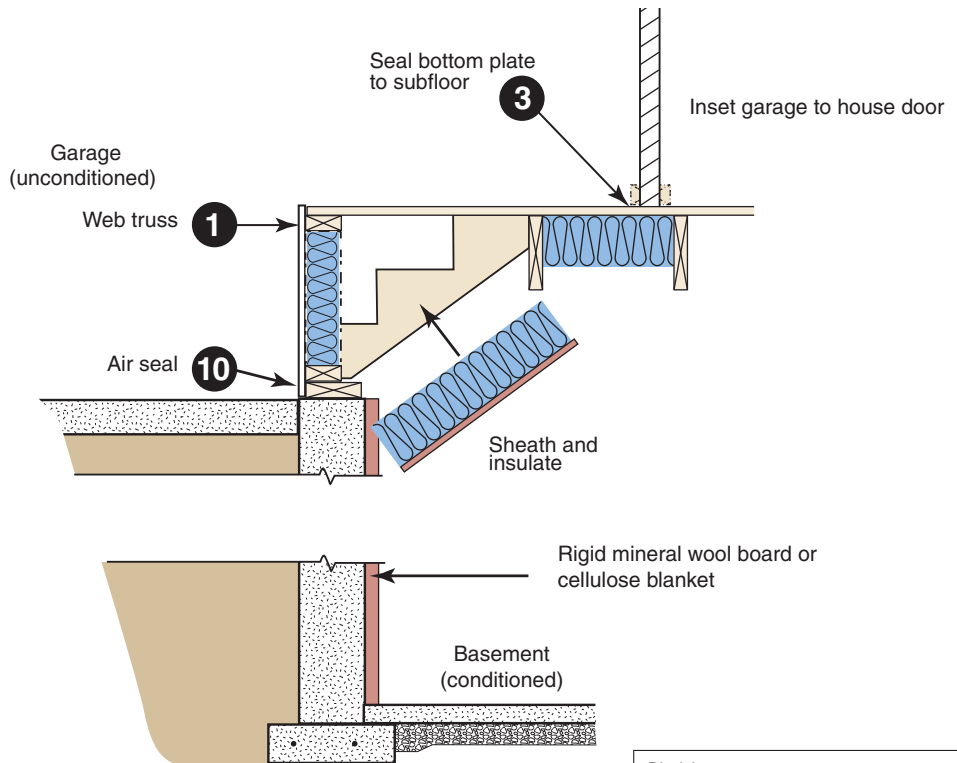
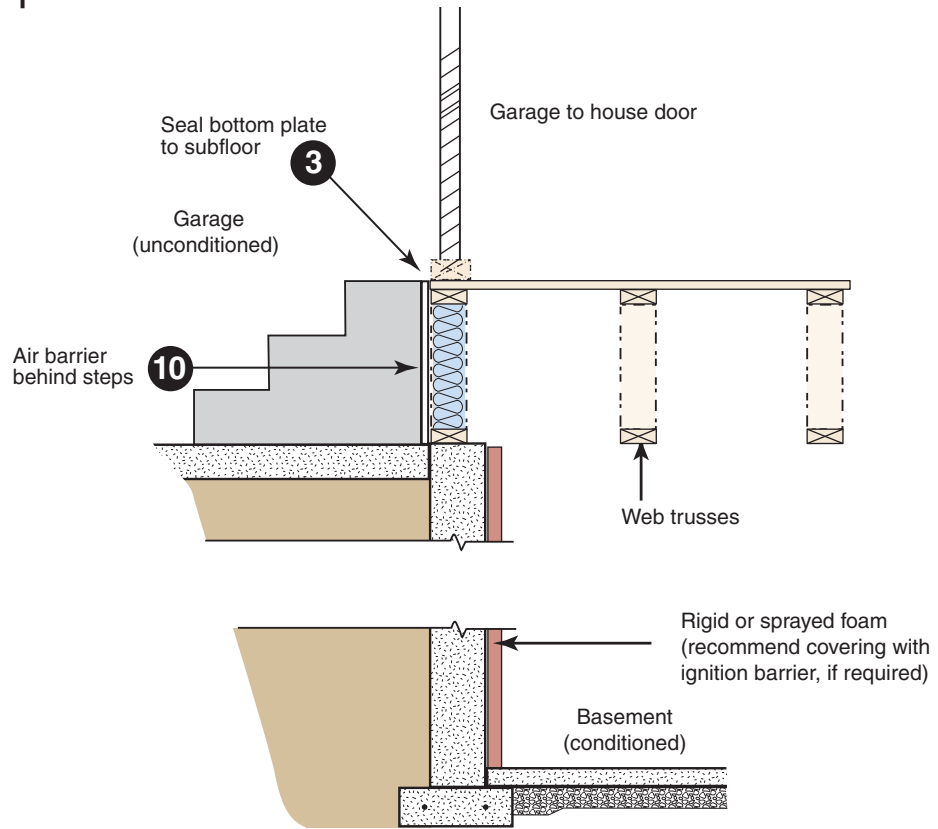

Disclaimer:
This document was created by Southface and is intended solely to help graphically demonstrate the air leakage and insulation provisions of the 2015 IECC (2020 Georgia Energy Code). It does not cover all air sealing locations, materials or techniques. Other code provisions may be applicable as well.

Duct Sealing key points

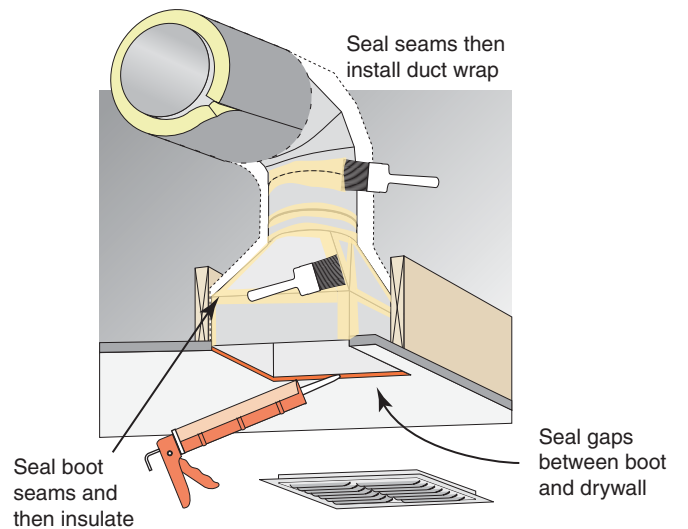
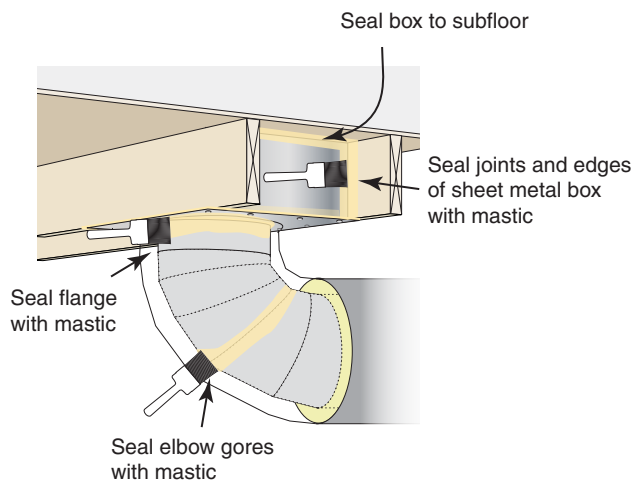
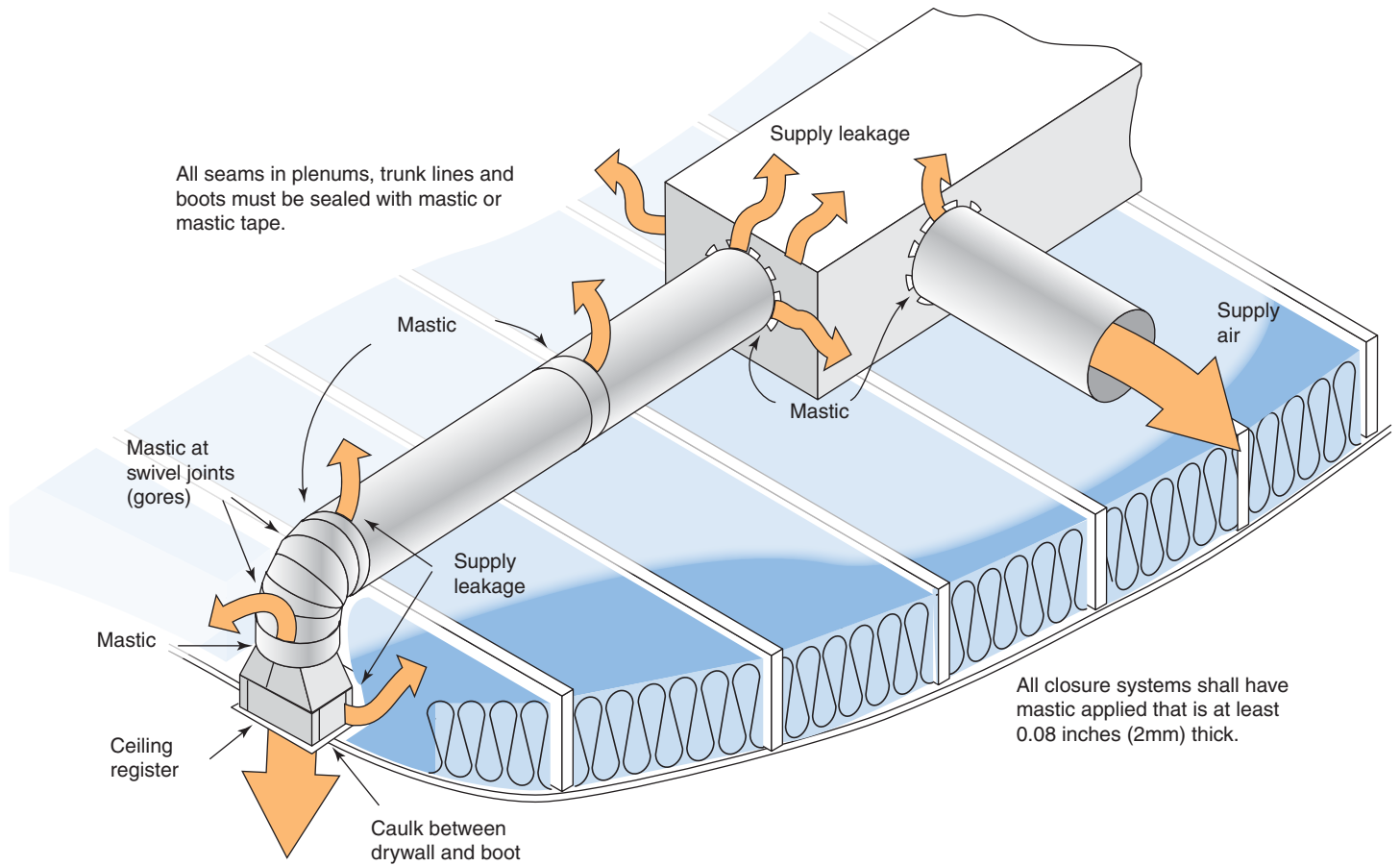

Disclaimer:
 This document was created by Southface and is intended solely to help graphically demonstrate the air leakage and insulation provisions of the 2015 IECC (2020 Georgia Energy Code). It does not cover all air sealing locations, materials or techniques. Other code provisions may be applicable as well.

Air Handler Sealing key points

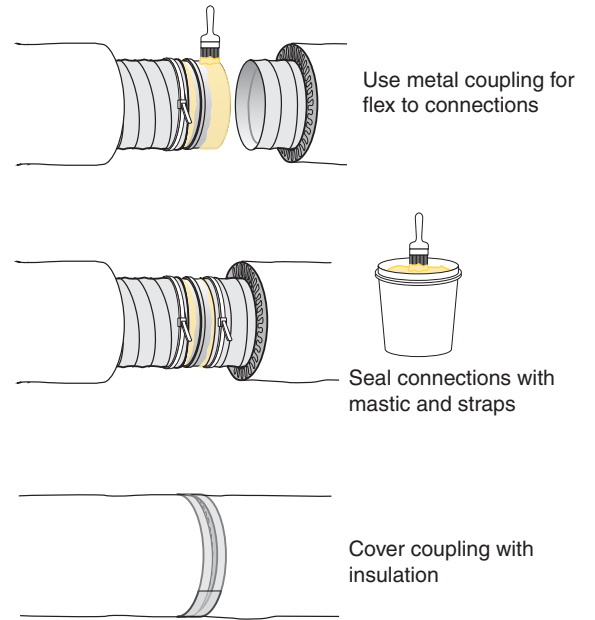
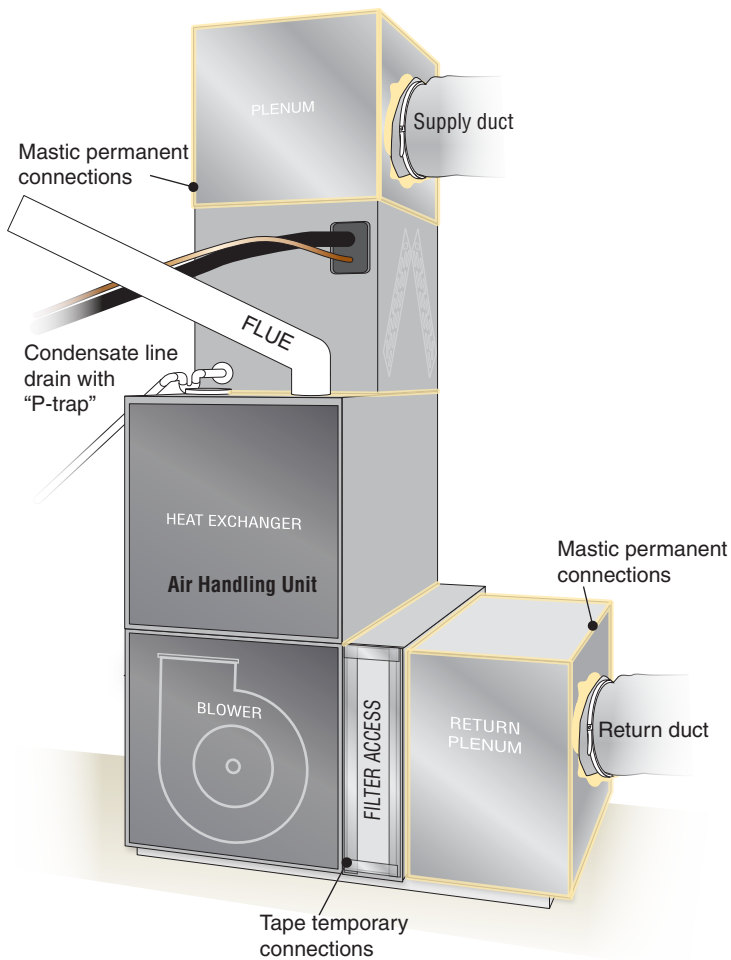
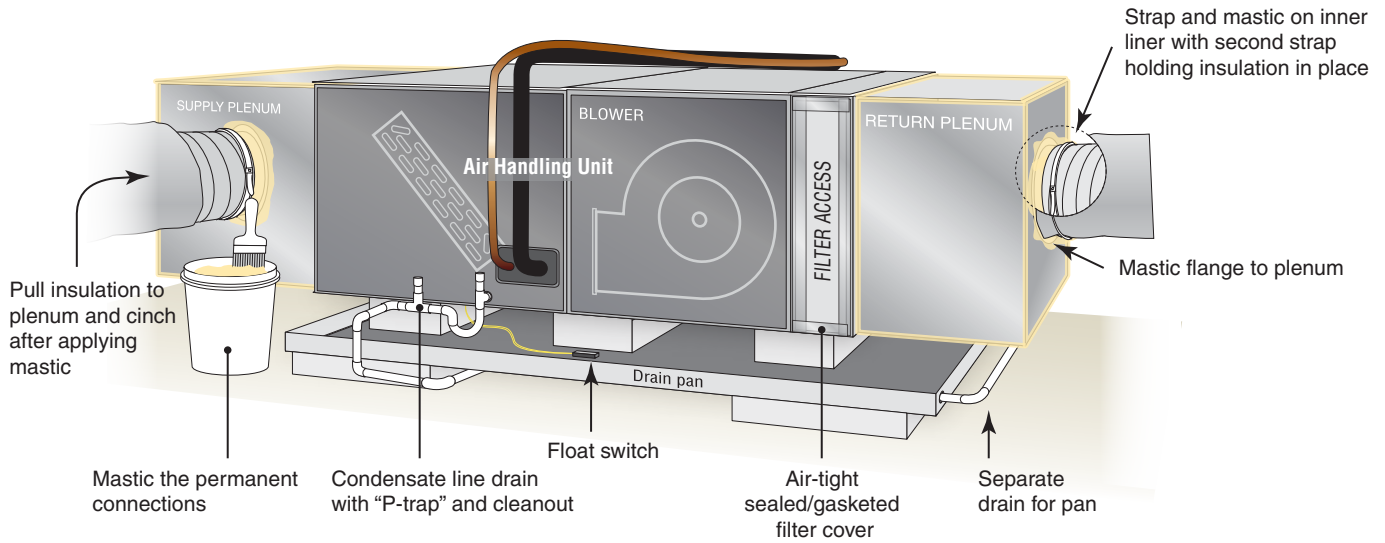

Disclaimer:
 This document was created by Southface and is intended solely to help graphically demonstrate the air leakage and insulation provisions of the 2015 IECC (2020 Georgia Energy Code). It does not cover all air sealing locations, materials or techniques. Other code provisions may be applicable as well.

Air sealing key points *continued*

Multifamily

Multifamily Air-sealing Details

- 8 Cap and seal all chases including chases for grouped utility lines and radon vents

Seal penetrations in mechanical closet including penetrations for the:

- 8 supply plenum
 - 8 outside air ventilation
 - 8 12 refrigerant line
 - 12 plumbing
 - 12 14 electrical
 - 12 gas fuel
- 5 Seal band area at exterior sheathing side and all penetrations through band
 - 1 3 UL-compliant air sealing at drywall finishing for any wall adjacent to stairwell or elevator. Air seal this gap at every change in floor level
 - 8 Seal miscellaneous clustered penetrations through building envelope (e.g. refrigerant lines)

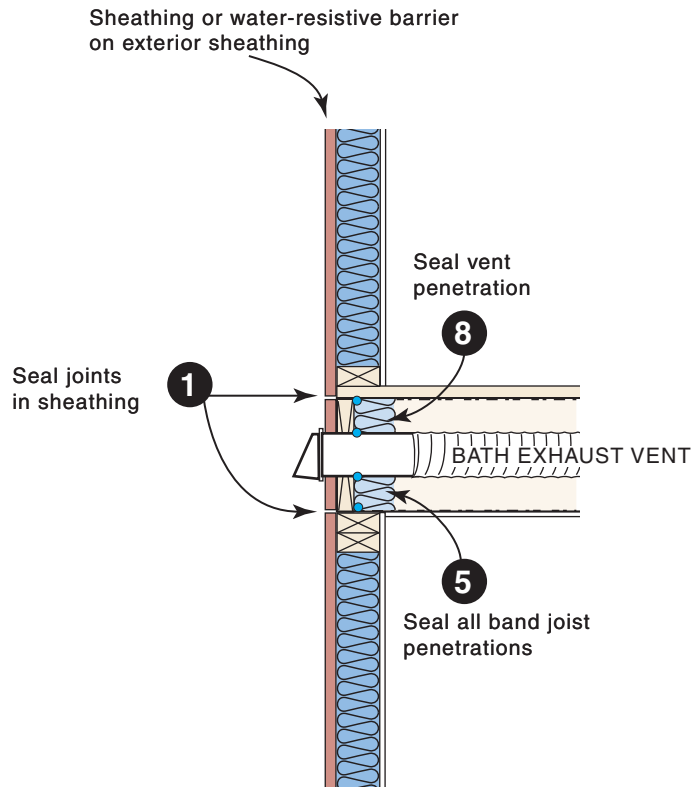

Disclaimer:
 This document was created by Southface and is intended solely to help graphically demonstrate the air leakage and insulation provisions of the 2015 IECC (2020 Georgia Energy Code). It does not cover all air sealing locations, materials or techniques. Other code provisions may be applicable as well.

Air sealing key points *continued*

Multifamily

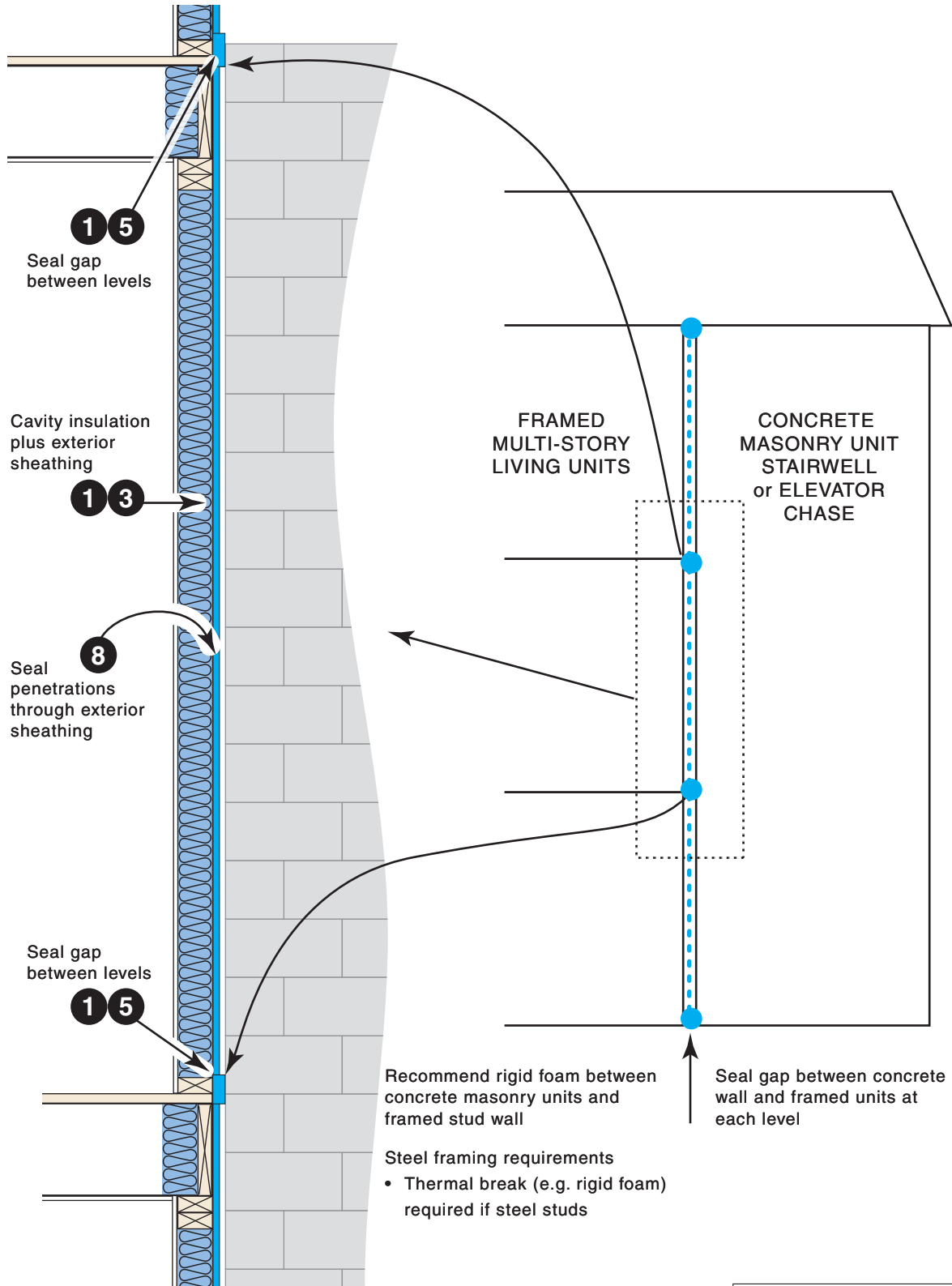

Disclaimer:
This document was created by Southface and is intended solely to help graphically demonstrate the air leakage and insulation provisions of the 2015 IECC (2020 Georgia Energy Code). It does not cover all air sealing locations, materials or techniques. Other code provisions may be applicable as well.

Air sealing key points *continued*

Multifamily Mechanical Closet

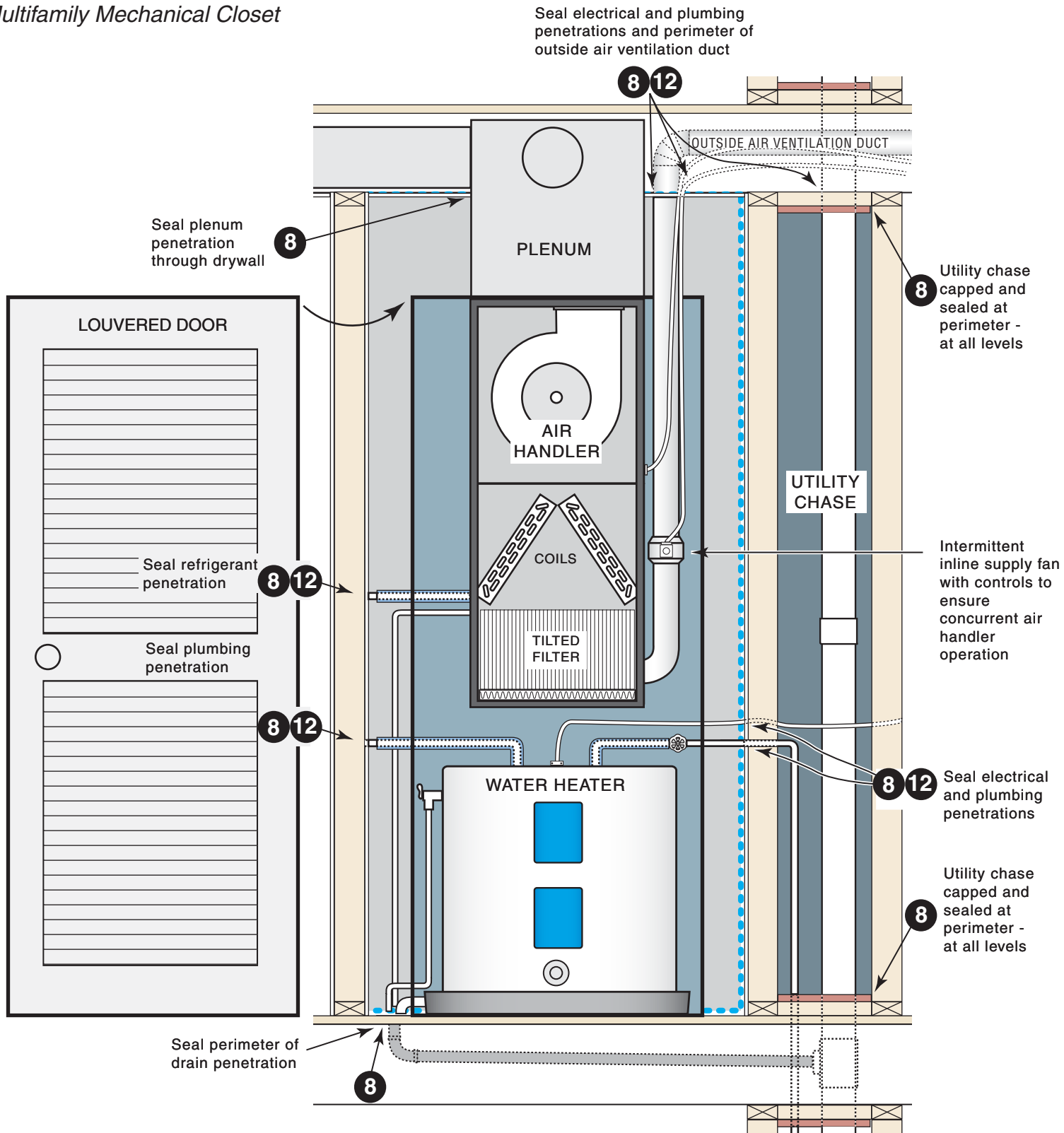

Disclaimer:
This document was created by Southface and is intended solely to help graphically demonstrate the air leakage and insulation provisions of the 2015 IECC (2020 Georgia Energy Code). It does not cover all air sealing locations, materials or techniques. Other code provisions may be applicable as well.

Building Thermal Envelope — The basement walls, exterior walls, floor, roof, and any other building element that enclose conditioned space. This boundary also includes the boundary between conditioned space and any exempt or unconditioned space. —2015 IECC

The *building thermal envelope* is the barrier that separates the conditioned space from the outside or unconditioned spaces. The building envelope consists of two parts - an air barrier and a thermal barrier that must be both continuous and contiguous (touching each other). In a typical residence, the building envelope consists of the roof, walls, windows, doors, and foundation. Examples of unconditioned spaces include attics, vented crawlspaces, garages, and basements with ceiling insulation and no HVAC supply registers.

Example 1 – Prescriptive Compliance

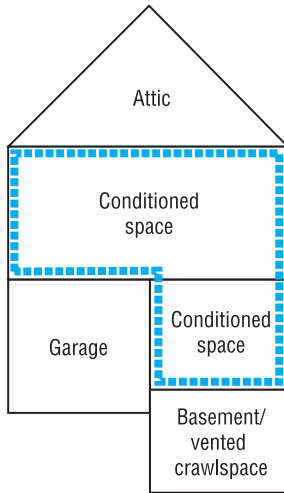

Example 2 – Alternate Compliance

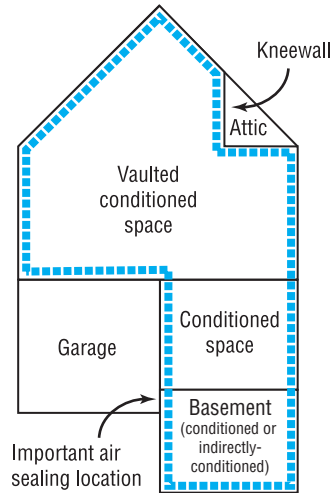

Example 3 – Alternate Compliance

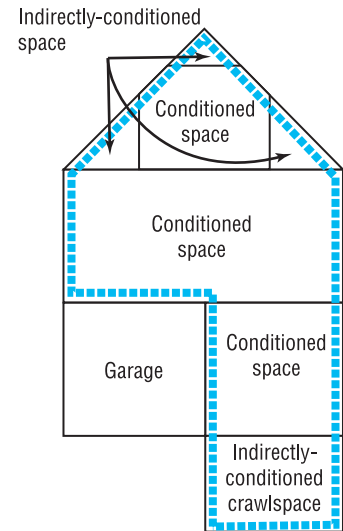

This is a conventional approach that likely locates all ductwork in unconditioned spaces.

Prescriptive R-values

- Flat ceiling: R-38
- Exterior walls: R-13
- Floor over garage and basement/crawl: R-19 (climate zones 3 & 4)
- Ductwork sealed with mastic and insulated to R-8 in attic, R-6 in basement/crawlspace
- Garage⁵, attic and basement/crawl are unconditioned spaces

If supply registers deliver conditioned air to basement, it is considered conditioned. With no supply air, it is considered an indirectly-conditioned space.

Example R-values¹

- Flat ceiling: R-38
- Kneewalls: R-18 (required)² (R-13+ R-5, R-15 + R-3, R-19 in 2x6)
- Vaulted ceiling: R-20 air-permeable insulation plus R-5 rigid foam board³
- Exterior walls: R-13
- Basement masonry walls: R-5
- Basement slab: R-0⁴
- Ductwork sealed with mastic and insulated to R-8 in attic, R-6 in basement
- Garage⁵ and attic are unconditioned spaces

The top conditioned floor functions as a vaulted ceiling with interior walls although it appears to have kneewalls and a flat ceiling. An advantage of this approach is that all upstairs ductwork is located inside the building envelope.

The crawlspace walls are insulated and do not contain vents. The crawlspace ground is covered with 100% plastic and functions as a “mini-basement.”

Example R-values¹

- Vaulted ceiling: R-20 air-impermeable foam insulation³
- Exterior walls: R-13 + R-5 sheathing
- Crawlspace walls: R-5
- Ductwork sealed with mastic and insulated to R-6
- Garage⁵ is unconditioned space

1 R-values shown are examples and not necessarily prescriptive code requirements. Refer to the Georgia Energy Code for specific prescriptive insulation requirements.

2 An attic kneewall is any vertical wall that separates conditioned space from an unconditioned attic. In Georgia, kneewalls must be insulated to R-18. A sealed attic-side air barrier (OSB, foil-faced sheathing, etc.) is required when using air permeable insulation.

3 Requires trade-off since prescriptive ceiling requirement is R-38, see roofline installed insulation options and section 806.5 of the 2012 IRC.

4 Slab insulation is not required in Georgia due to termite risk.

5 Although there is nothing to prevent the garage walls from being insulated, due to indoor air quality concerns, the garage should never be considered inside the building

Disclaimer:
This document was created by Southface and is intended solely to help graphically demonstrate the air leakage and insulation provisions of the 2015 IECC (2020 Georgia Energy Code). It does not cover all air sealing locations, materials or techniques. Other code provisions may be applicable as well.

Insulation Details for Ceilings with Attic spaces

Rafter and Truss

Standard Truss
with tapered
insulation depth

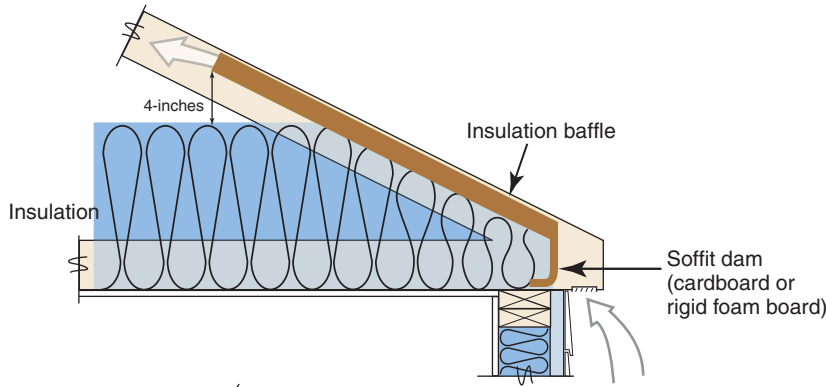

Note: Wind wash baffle and air-permeable insulation dam. For air permeable insulation in vented attics, baffles shall be installed adjacent to soffit and eave vents. A minimum of a 1-inch of space shall be provided between the insulation and the roof sheathing and at the location of the vent. The baffle shall extend over the top of the insulation inward until it is at least 4 inches vertically above the top of the insulation. Any solid material such as cardboard or thin insulating sheathing shall be permissible as the baffle.

Energy Truss
with full height insulation
(recommended)

NOTE:
R-30 complete coverage
is deemed equivalent to
prescriptive R-38

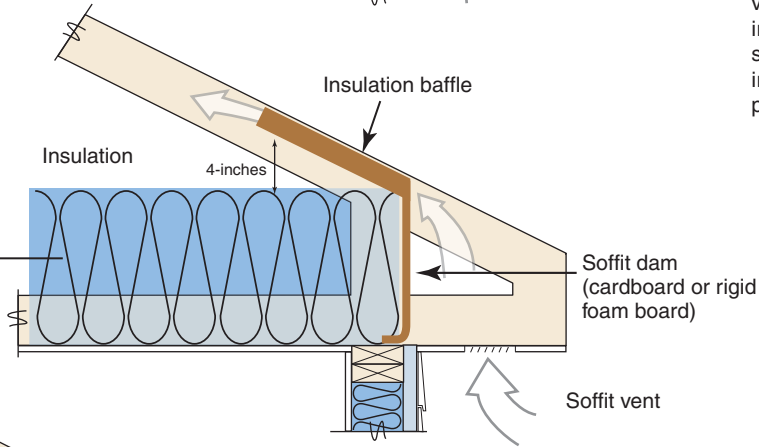

Standard rafter
and top plate
with tapered
insulation depth

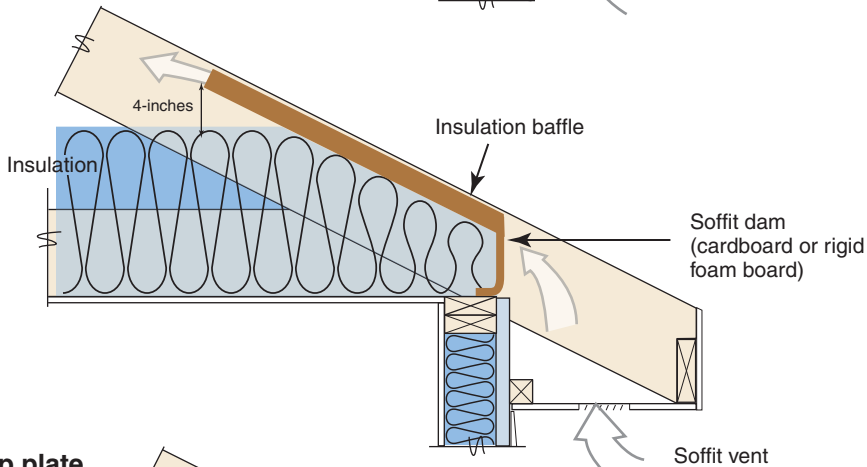

Rafter on raised top plate
with full height insulation
(recommended)

NOTE:
R-30 complete coverage
is deemed equivalent to
prescriptive R-38

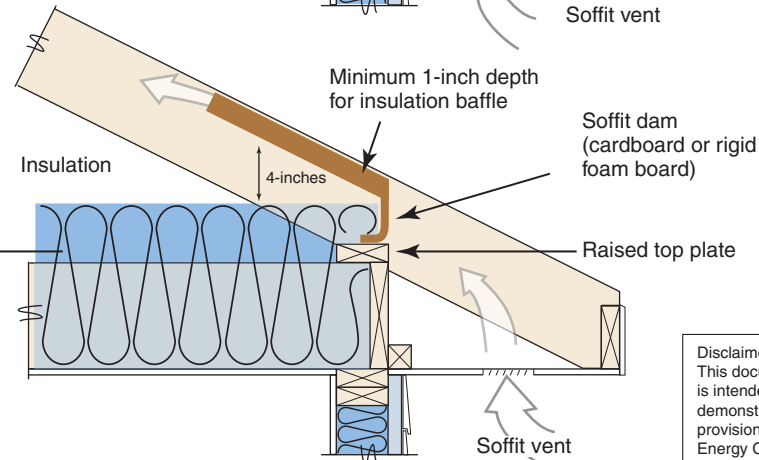

Disclaimer:
This document was created by Southface and is intended solely to help graphically demonstrate the air leakage and insulation provisions of the 2015 IECC (2020 Georgia Energy Code). It does not cover all air sealing locations, materials or techniques. Other code provisions may be applicable as well.

Roofline Installed Insulation Options

Reference Table 402.1.1 and 402.1.6 in the Georgia Energy Code amendments to the 2015 IECC and Section 806.5 "unvented attic assemblies" in the Georgia Amendments to the 2012 IRC

Vaulted unvented attic – roofline air-impermeable insulation (e.g., spray foam insulation)

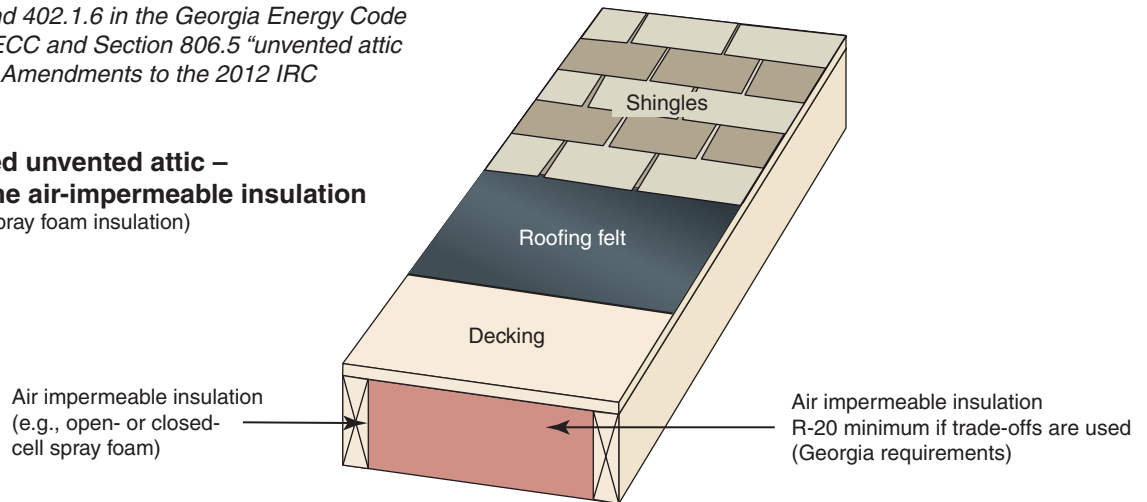

Vaulted unvented attic – roofline air-permeable insulation (e.g., fiberglass, cellulose insulation)

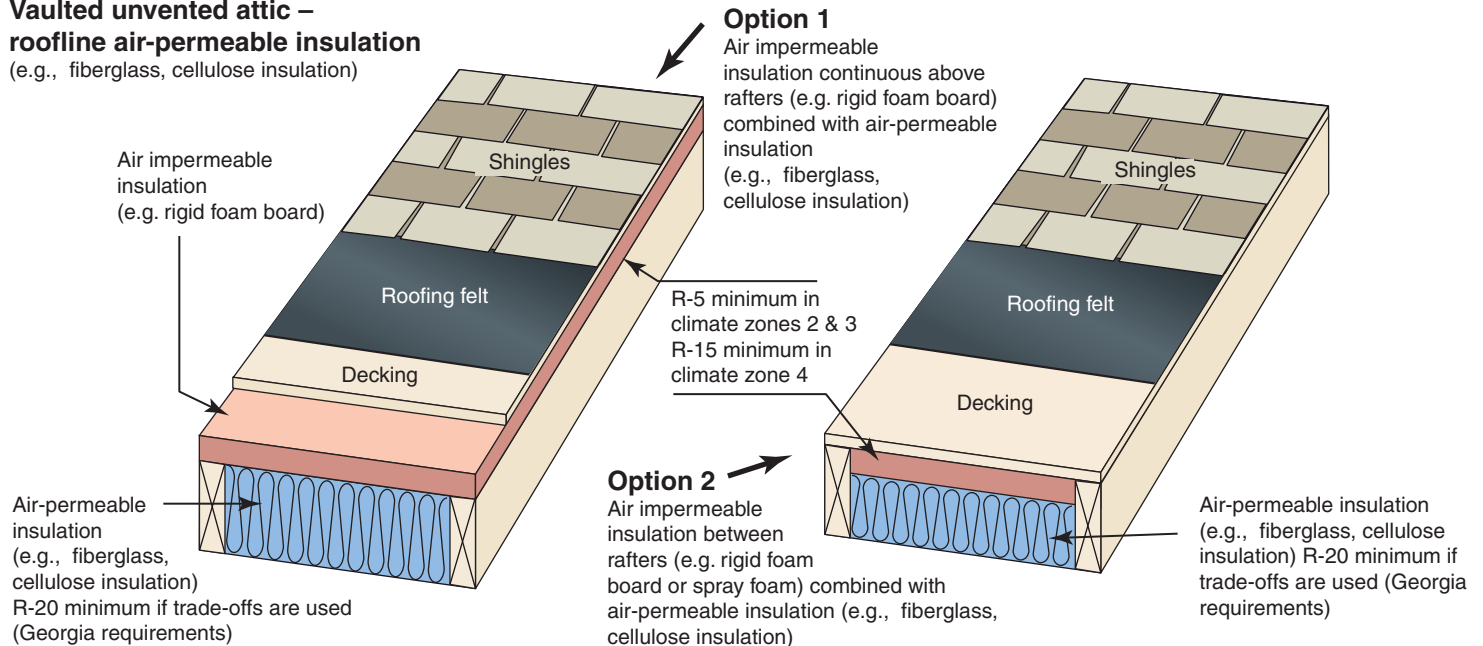

Cathedralized vented ceiling – roofline air-permeable insulation (e.g., fiberglass, cellulose insulation)

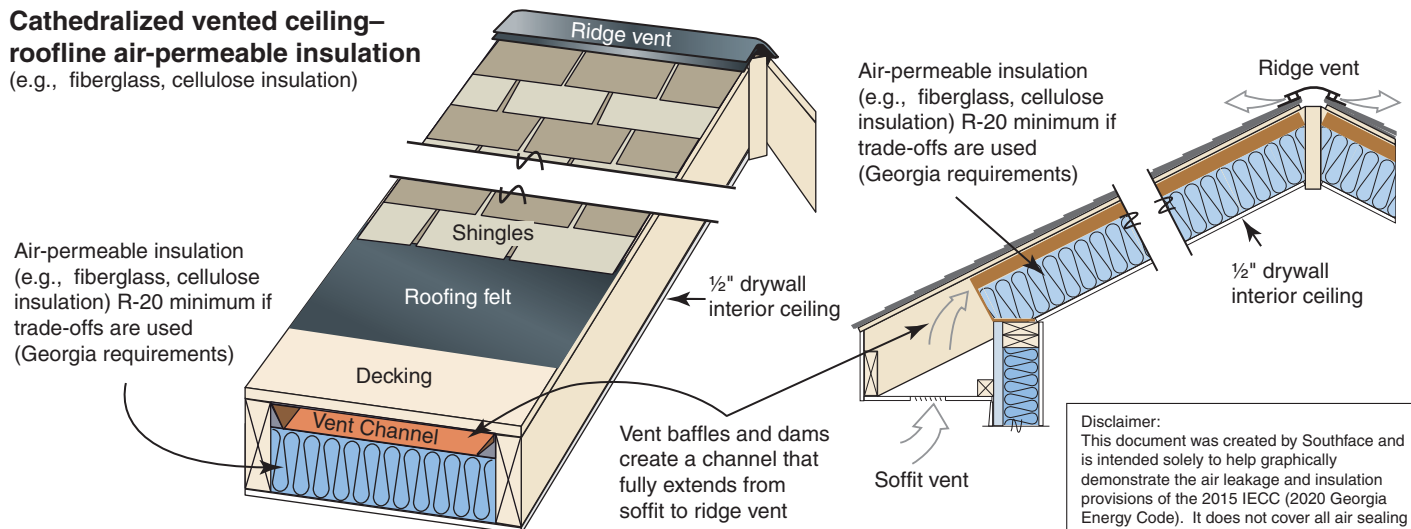

Disclaimer:
This document was created by Southface and is intended solely to help graphically demonstrate the air leakage and insulation provisions of the 2015 IECC (2020 Georgia Energy Code). It does not cover all air sealing locations, materials or techniques. Other code provisions may be applicable as well.

Georgia Insulation Installation – *Passing Grade Details*

Wall and ceiling insulation that makes up portions of the building thermal envelope shall be installed to Passing Grade quality.

Two criteria affect installed insulation grading: **voids/gaps** (in which no insulation is present in a portion of the overall insulated surface) and **compression/incomplete fill** (in which the insulation does not fully fill out or extend to the desired depth).

Voids/Gaps

- Voids or gaps in the insulation are < 1% of overall component surface area (only occasional and very small gaps allowed for Passing Grade)

Compression/Incomplete Fill

- Compression/Incomplete Fill for both *air permeable insulation* (e.g., fiberglass, cellulose) and *air impermeable insulation* (e.g., spray polyurethane foam) must be less than 1 inch in depth or less than 30% of the intended depth, whichever is more stringent. The allowable area of compression/incomplete fill must be less than 2% of the overall insulated surface to achieve a Passing Grade.
- Any compression/incomplete fill with a **depth** greater than the above specifications (up to 1" or 30% of the intended depth, whichever is more stringent) shall not achieve a Passing Grade.

Additional Wall Insulation Requirements

- All vertical air permeable insulation shall be installed in substantial contact with an air barrier on all six (6) sides. **Exception:** Unfinished basements, rim/band joist cavity insulation and fireplaces (insulation shall be restrained to stay in place).
For unfinished basements, air permeable insulation and associated framing in a framed cavity wall shall be installed less than ¼" from the basement wall surface.
- Attic knee wall details – Attic knee walls shall be insulated to a total R-value of at least R-18 through any combination of cavity and continuous insulation. Air permeable insulation shall be installed with a fully sealed attic-side air barrier (e.g., OSB with seams caulked, rigid insulation with joints taped, etc.). Attic knee walls with air impermeable insulation shall not require an additional attic-side air barrier.

Underfloor insulation that makes up portions of the building thermal envelope shall be installed to Passing Grade quality.

Two criteria affect installed insulation grading: **voids/ gaps** (in which no insulation is present in a portion of the overall insulated surface) and **compression/incomplete fill** (in which the insulation does not fully fill out or extend to the desired depth).

Voids/Gaps

- Voids or gaps in the insulation are minimal for Passing Grade (< 2% of overall component surface area)

Compression/Incomplete Fill

- Compression/Incomplete Fill for both *air permeable insulation* (e.g., fiberglass, cellulose) and *air impermeable insulation* (e.g., spray polyurethane foam) must be less than 1 inch in depth or less than 30% of the intended depth, whichever is more stringent. The allowable area of compression/incomplete fill must be less than 10% of the overall insulated surface to achieve a Passing Grade.
- Any compression/incomplete fill with a **depth** greater than the above specifications (up to 1" or 30% of the intended depth, whichever is more stringent) shall not achieve a Passing Grade.
- Air-permeable underfloor insulation shall be permanently installed against the subfloor decking. Adequate insulation supports (e.g., wire staves) for air permeable insulation shall be installed at least every 18-24".
Exception: The floor framing-cavity insulation shall be permitted to be in contact with the topside of sheathing or continuous insulation installed on the bottom side of floor framing where combined with insulation that meets or exceeds the minimum wood frame wall R-value and that extends from the bottom to the top of all perimeter floor framing members.

Disclaimer:

This document was created by Southface and is intended solely to help graphically demonstrate the air leakage and insulation provisions of the 2015 IECC (2020 Georgia Energy Code). It does not cover all air sealing locations, materials or techniques. Other code provisions may be applicable as well.

Wall Insulation key points

Voids / Gaps

Passing Grade 

Insulation is notched and completely surrounds electrical box

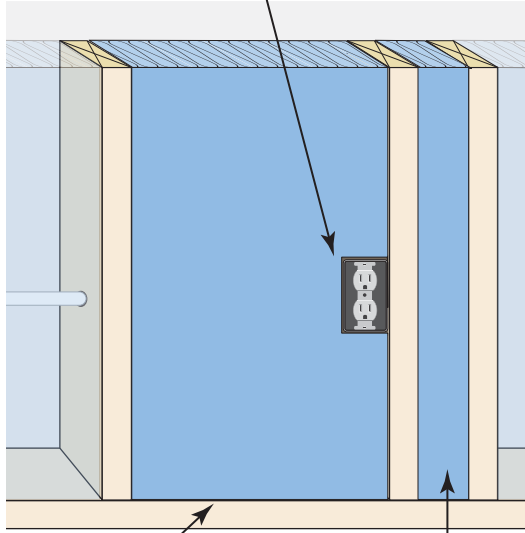

Insulation fully fills cavity at top and bottom

Narrow cavity fully insulated

Unacceptable Installation 

Incomplete insulation coverage around electrical box

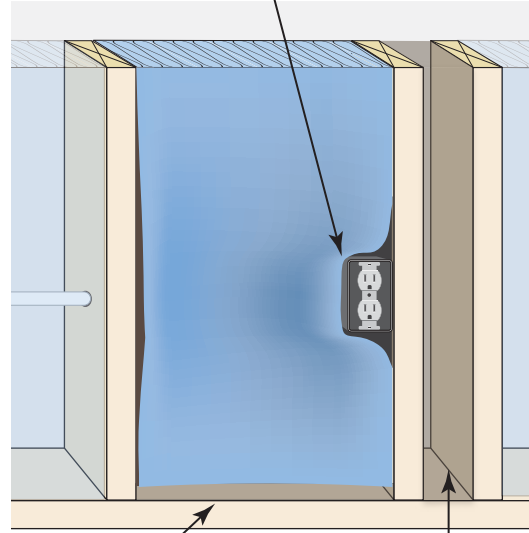

Insulation does not extend to bottom of cavity

Narrow cavity not insulated

Compression / Incomplete Fill

Passing Grade 

Insulation is slit around electrical wire

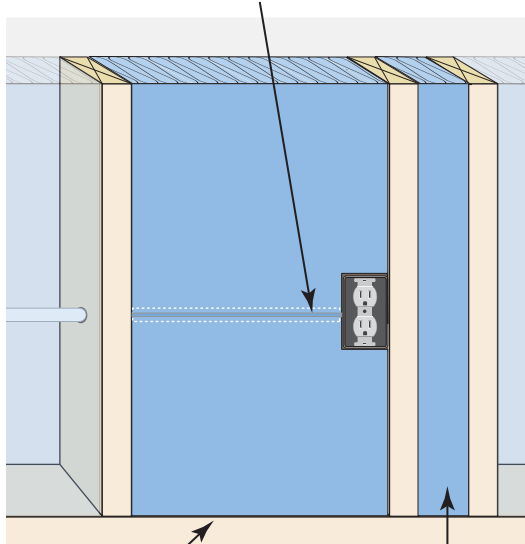

Insulation extends from front to back and fully fills entire cavity

Proper width insulation fully fills narrow cavity

Unacceptable Installation 

Insulation is compressed behind electrical wire

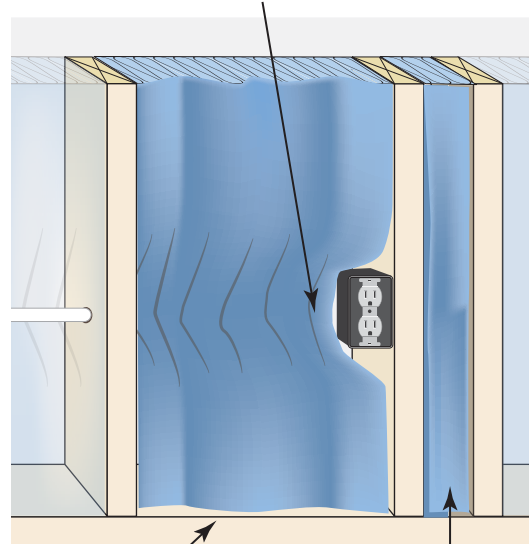

Insulation does not fully fill entire cavity

Improper width insulation is compressed into narrow cavity

Disclaimer:
This document was created by Southface and is intended solely to help graphically demonstrate the air leakage and insulation provisions of the 2015 IECC (2020 Georgia Energy Code). It does not cover all air sealing locations, materials or techniques. Other code provisions may be applicable as well.

Ceiling Insulation key points

Passing Grade 

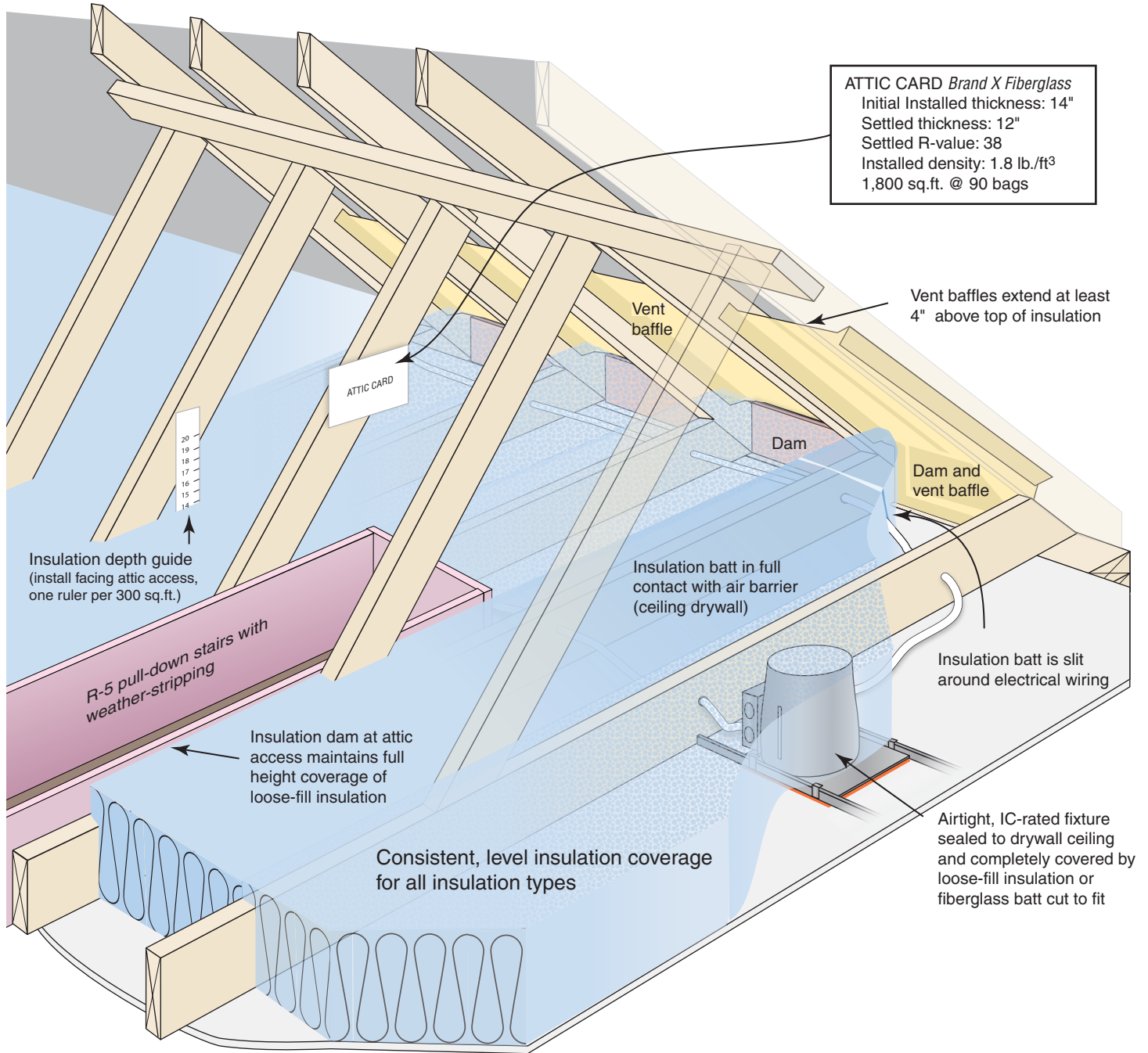

Disclaimer:
This document was created by Southface and is intended solely to help graphically demonstrate the air leakage and insulation provisions of the 2015 IECC (2020 Georgia Energy Code). It does not cover all air sealing locations, materials or techniques. Other code provisions may be applicable as well.

Ceiling Insulation key points

Unacceptable installation 

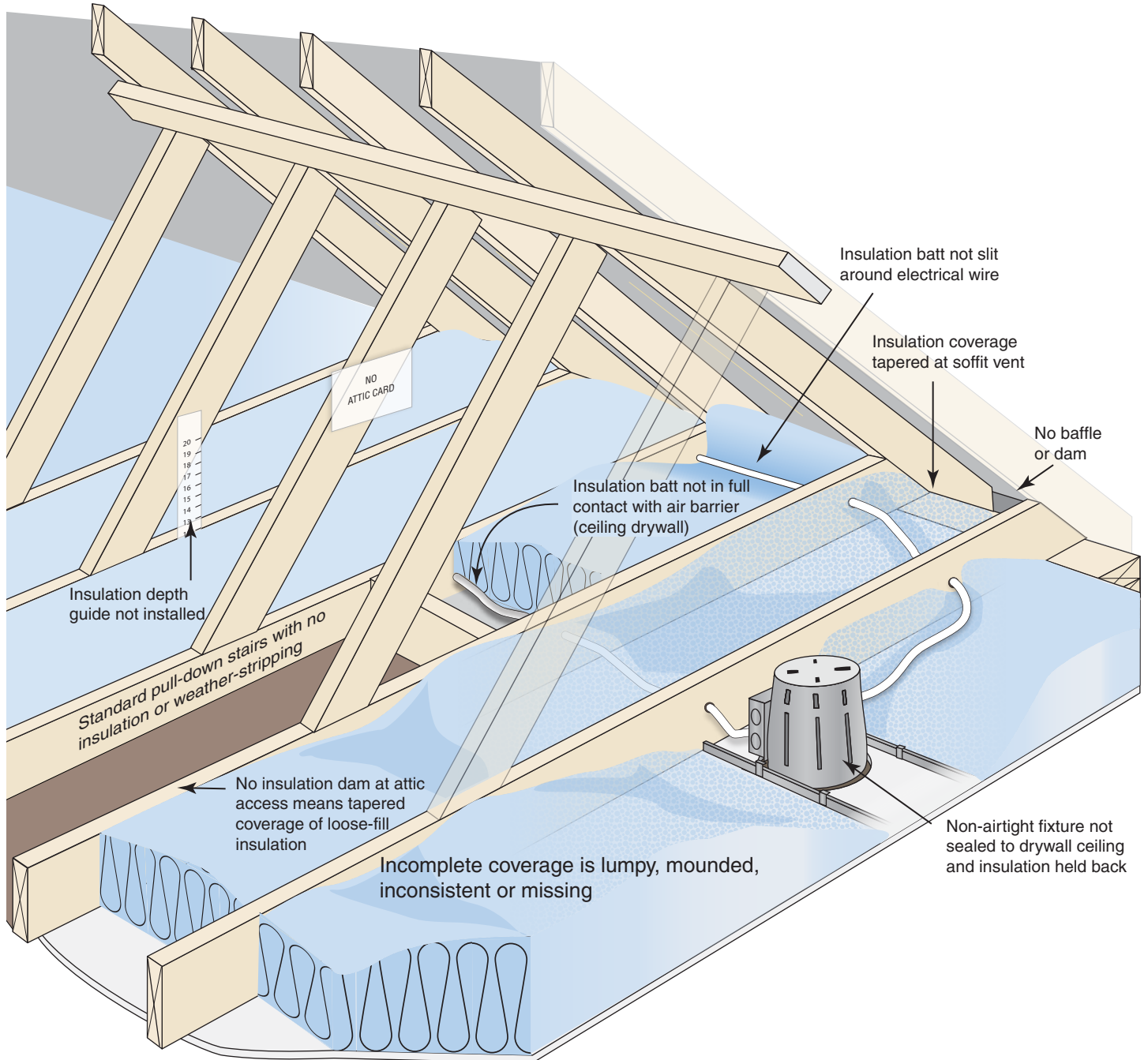

Disclaimer:
This document was created by Southface and is intended solely to help graphically demonstrate the air leakage and insulation provisions of the 2015 IECC (2020 Georgia Energy Code). It does not cover all air sealing locations, materials or techniques. Other code provisions may be applicable as well.

Floor Insulation key points

Passing Grade

Installed insulation is in complete contact with air barrier (subfloor)

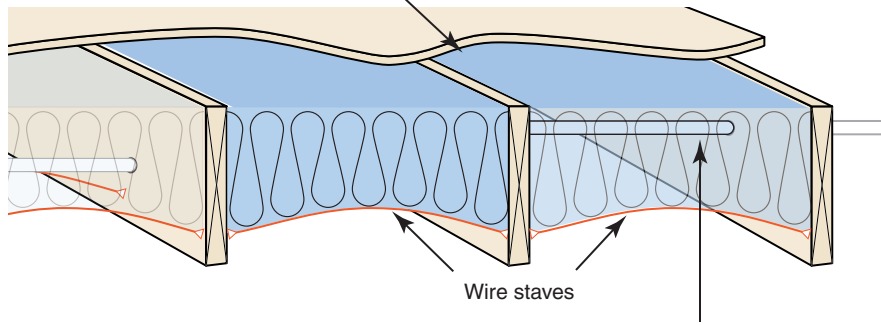

Insulation coverage is complete

Insulation is slit around plumbing and wiring and securely fastened with minimal compression

Unacceptable Installation

Insulation is not installed in complete contact with air barrier (subfloor)

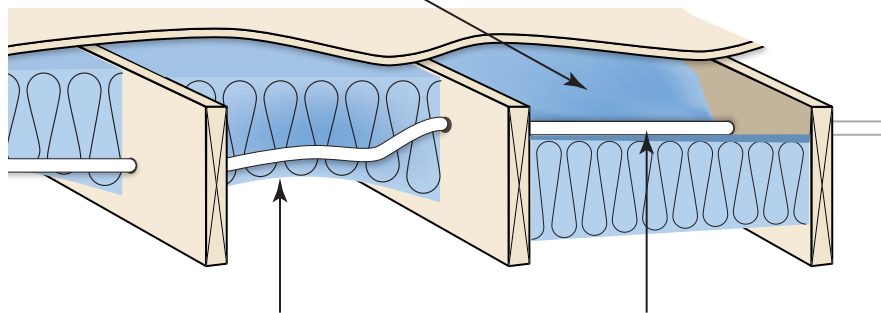

Insulation coverage is incomplete due to obstructions (plumbing, electrical, ductwork, etc.)

Insulation is compressed around plumbing and wiring and is not securely fastened

Disclaimer:
This document was created by Southface and is intended solely to help graphically demonstrate the air leakage and insulation provisions of the 2015 IECC (2020 Georgia Energy Code). It does not cover all air sealing locations, materials or techniques. Other code provisions may be applicable as well.

**APPENDIX RC
THIRD PARTY VERIFICATION**

**SECTION RC101
GENERAL**

RC101.1 Scope. The provisions of this appendix govern the requirements for third-party verification of this code.

RC101.2 Adoption. The authority having jurisdiction may adopt this appendix to utilize third-party verification of this code.

**SECTION RC102
DEFINITIONS**

THIRD-PARTY VERIFIER. An independent person or firm responsible for conducting inspections and/or testing and plan review to verify a project's compliance with the provisions of this code.

**SECTION RC103
QUALIFICATIONS**

RC103.1 General. It shall be the responsibility of the permit holder to retain a qualified *third-party verifier*. The *third-party verifier* shall not be an employee of the owner or builder or have a financial interest in the project.

RC103.2 Residential buildings. Third-party verifiers shall have one of the following minimum qualifications to conduct inspections or plan review for the energy efficiency provisions of *residential buildings* as defined by this code:

1. Accredited HERS Rater
2. ICC Residential Energy Inspector/Plans Examiner Certification
3. EarthCraft House Technical Advisor
4. Building Performance Institute (BPI) Analyst
5. Equivalent qualifications as approved by the local *code official*

Exception: Where the specific provisions of this code require additional qualifications.

RC103.3 Commercial buildings. Third-party verifiers shall have one of the following minimum qualifications to conduct inspections or plan review for the energy efficiency provisions of *commercial buildings* as defined by this code:

1. ICC Commercial Energy Inspector and ICC Commercial Plans Examiner Certifications
2. Equivalent qualifications as approved by the local *code official*

Exception: Where the specific provisions of this code require additional qualifications.

SECTION RC104 INSPECTIONS

RC104.1 General. Construction or work, conducted under the provisions of this code, for which a permit is required shall be subject to inspection by a *third-party verifier*.

RC104.2 Inspection requests. It shall be the duty of the permit holder or their duly authorized agent to notify the *third-party verifier* when work is ready for inspection and to provide access to and means for inspection of such work required by this code.

RC104.3 Fees. The permit holder shall be responsible for all fees charged by the *third-party verifier*.

RC104.4 Residential buildings. A minimum of two inspections shall be conducted for each residential building. The first inspection shall be conducted prior to the closing-up of building cavities; and shall include verification of compliance with the following: insulation, fenestration, air sealing and duct insulation and sealing. The second inspection shall be conducted after the building has been substantially completed and prior to issuance of a certificate of occupancy. The second inspection shall include verification of compliance with any portions of this code not verified during the first inspection.

RC104.5 Commercial buildings. A minimum number of inspections as determined by the *third-party verifier* shall be conducted to ensure verification of compliance with the provisions of Chapter 5 of this code or ASHRAE 90.1.

RC104.6 Re-inspection. A building shall be re-inspected when determined necessary by the *third-party verifier* or local *code official*.

RC104.7 Approval report. Inspection and verification reports shall be submitted by the *third party verifier* to the local *code official*.
(Effective January 1, 2020)

Appendix RD Mandatory Compliance Certificate

2019 Georgia Residential Energy Code Compliance Certificate		Jurisdiction Logo and/or Contact Information Here	
This certificate shall be permanently posted on or in the electrical distribution panel			
Permit # _____		House Address or Community/Lot# _____	
Building Summary			
Builder Company Name		Signature	Contact (email/phone)
			Date
Compliance Pathway (check one)		Building Envelope (when multiple values per component, list value covering largest area)	
<input type="checkbox"/> Prescriptive: R401-404		Ceiling/Roof R-value	Above-grade mass wall R-value
<input type="checkbox"/> UA Trade-off: R402.1.5		Sloped/vaulted ceiling R-value	Cantilevered floors R-value
<input type="checkbox"/> RESCheck: Keyed to 2015 IECC		Exterior wall R-value	Window/Glass Door SHGC
<input type="checkbox"/> Simulated Performance: R405		Kneewall (cavity and/or continuous) R-value	Window/Glass Door U-factor
<input type="checkbox"/> Energy Rating Index (ERI): R406		Foundation (cavity and/or continuous) R-value	Skylight SHGC
ERI Score		Floors over unconditioned R-value	Skylight U-factor
Mechanical Summary			
HVAC Company Name		Contact (email/phone)	Date
Heating System Type	Efficiency (AFUE, HSPF, COP or other)	Cooling System Type	Efficiency (SEER, EER or other)
<input type="checkbox"/> Gas		<input type="checkbox"/> Air conditioner	
<input type="checkbox"/> Heat pump		<input type="checkbox"/> Heat pump	
<input type="checkbox"/> Other		<input type="checkbox"/> Other:	
<input type="checkbox"/> Yes	<input type="checkbox"/> No	Manual J, S, D or equivalent complete?	
Required Mechanical Ventilation			
Type (check one)	Design Rate (check one)		
<input type="checkbox"/> Exhaust	<input type="checkbox"/> Continuous	Design Ventilation Rate (CFM)	
<input type="checkbox"/> Supply	<input type="checkbox"/> Intermittent		
<input type="checkbox"/> Balanced	If intermittent, list runtime in min. per hour		
Duct and Envelope Tightness Testing Summary			
DET Verifier		Contact (email/phone)	DET Verifier ID
Envelope Tightness Testing (< 5 ACH50) (Envelope Tightness = Blower Door Fan Flow x 60 / Thermal Envelope Volume)			
Blower Door Fan Flow (CFM50)		Thermal Envelope Volume (ft ³)	Envelope Tightness (ACH50)
If multifamily unit and conducting sampling, this unit is not required to be tested. Mark N/A.			
Duct Tightness Testing (< 4 CFM25/100 ft²) (Total Duct Leakage = 100 x Fan Flow / Area Served)			
Number of Heating and Cooling Systems			
Duct Tightness Leakage Test Results			
	System 1	System 2	System 3
If air handler and ductwork located entirely within in conditioned space, testing not required. Mark N/A.			
Location			
Fan Flow (CFM25)			
Area Served (ft ²)			
Total Duct Leakage (CFM25/100 ft ²)			
Rough In Total (RIT) or Post Construction Total (PCT)			

Version 1.0